

1

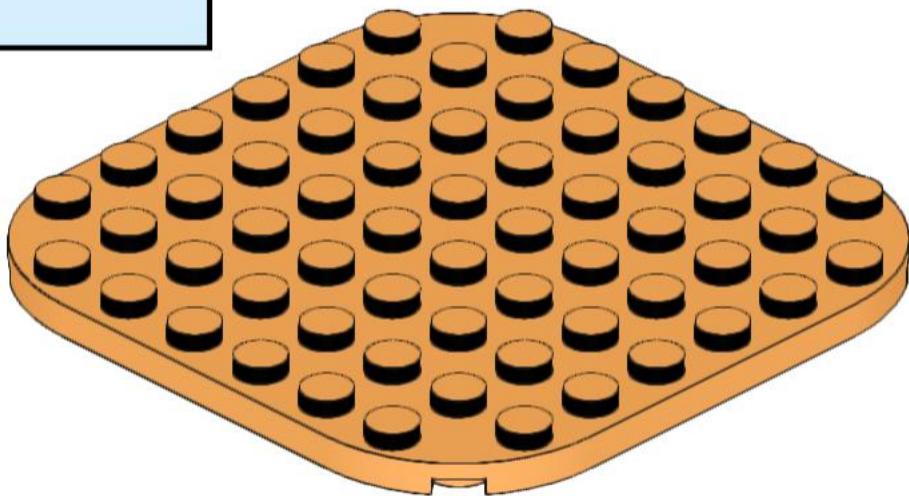

2

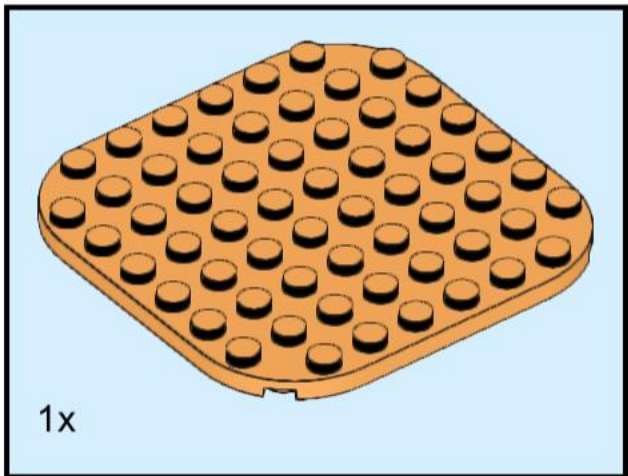
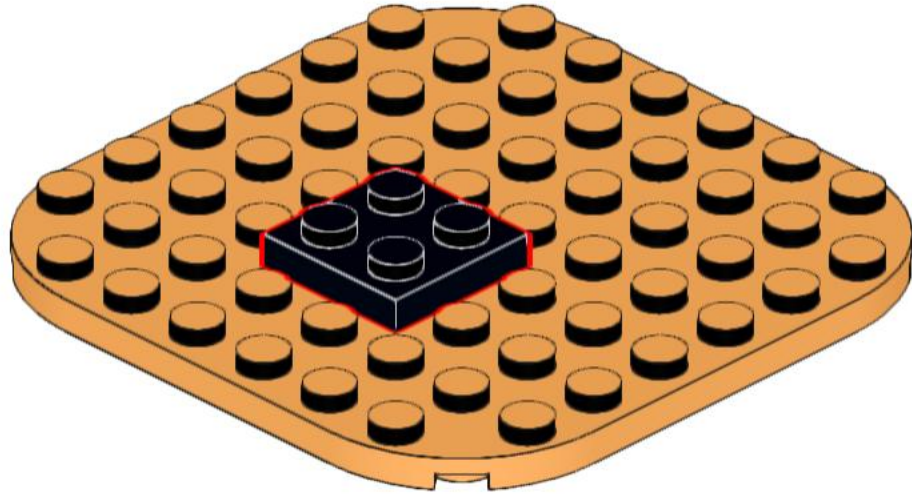
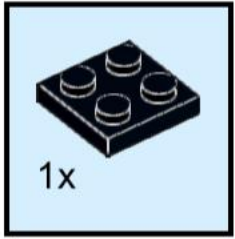

3

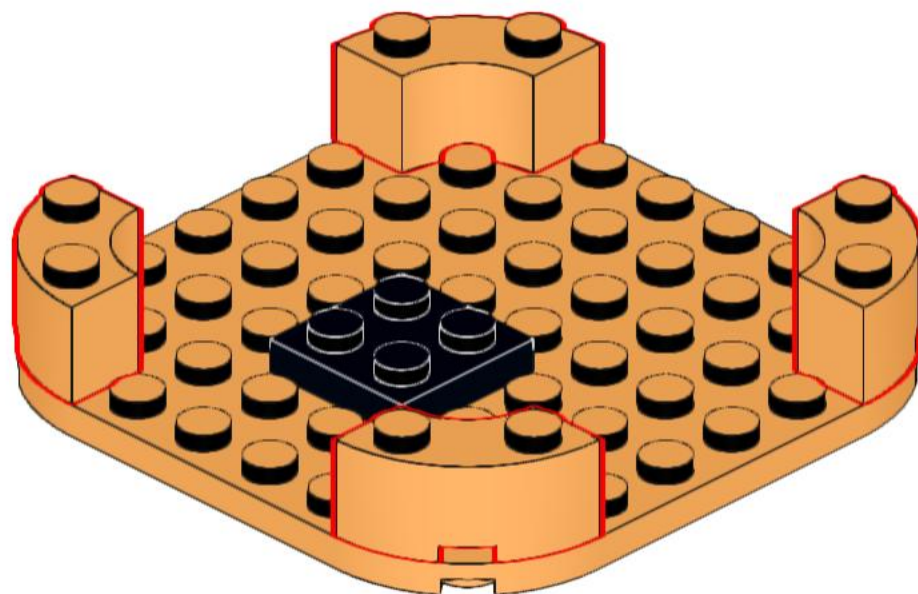
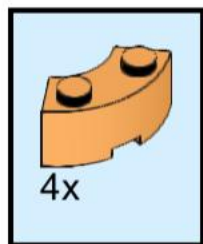

4

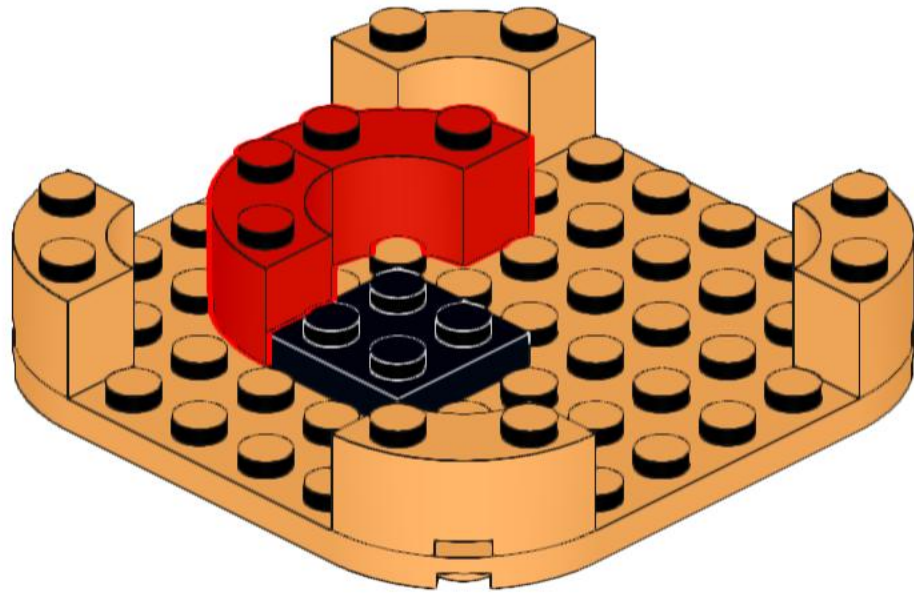
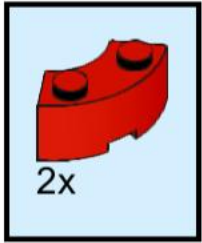

5

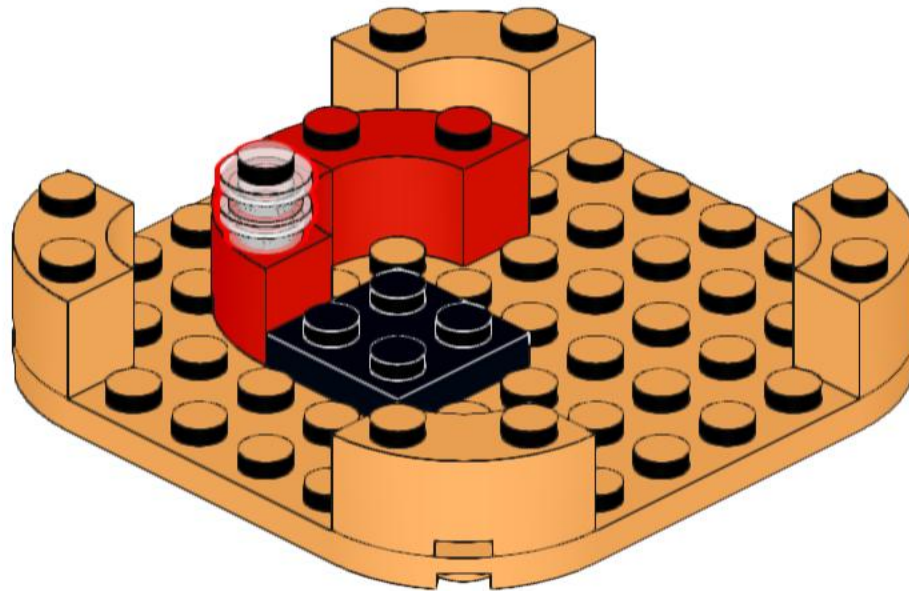

6

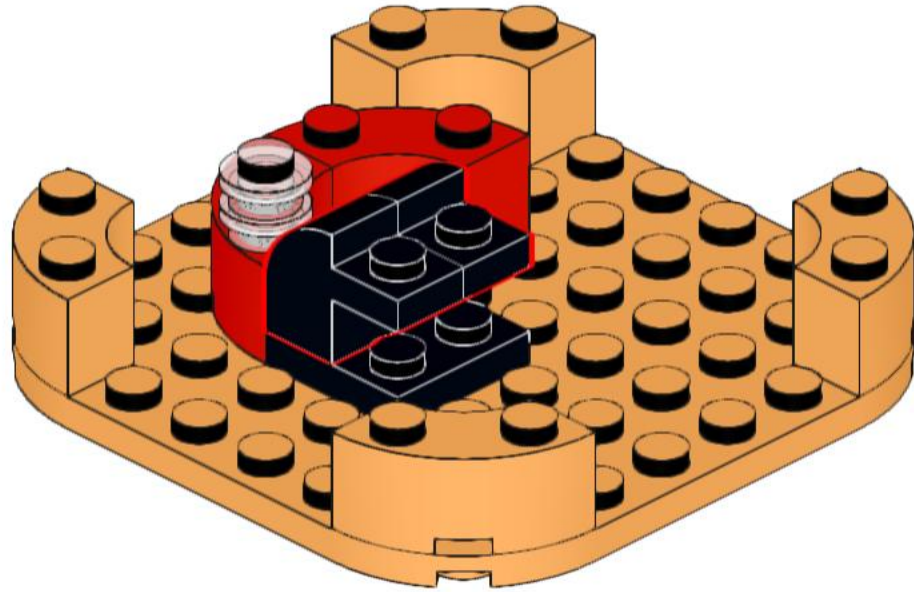

7

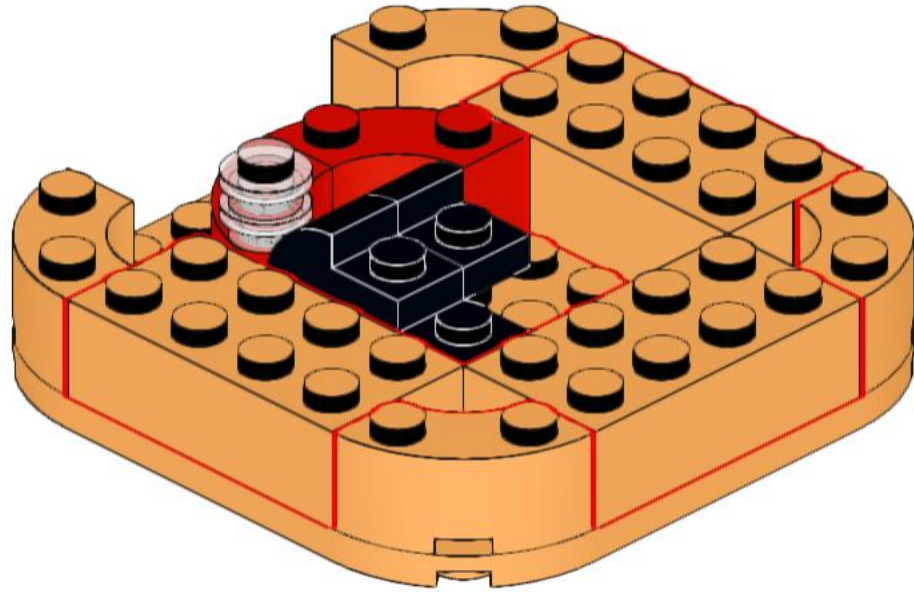
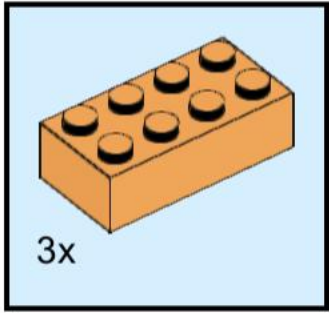

8

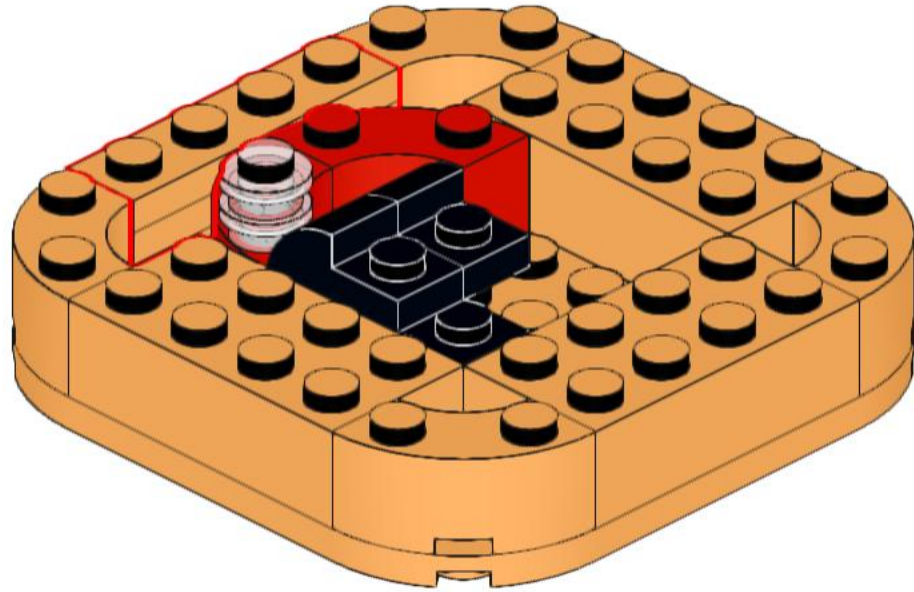
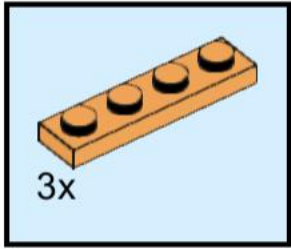

9

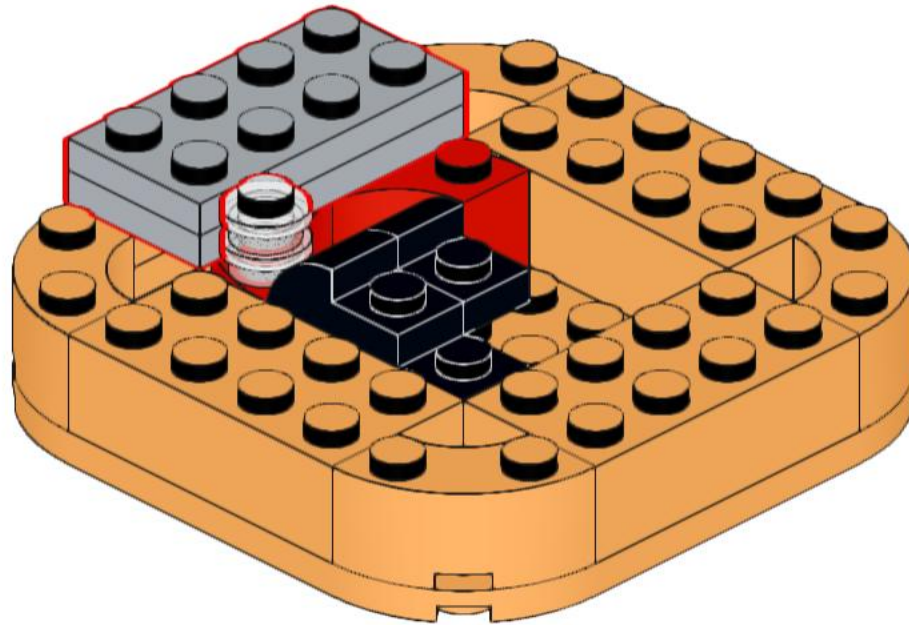
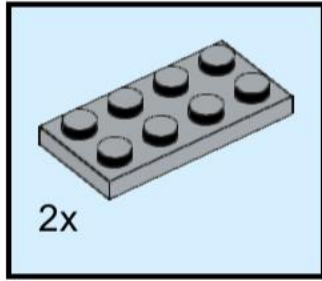

10

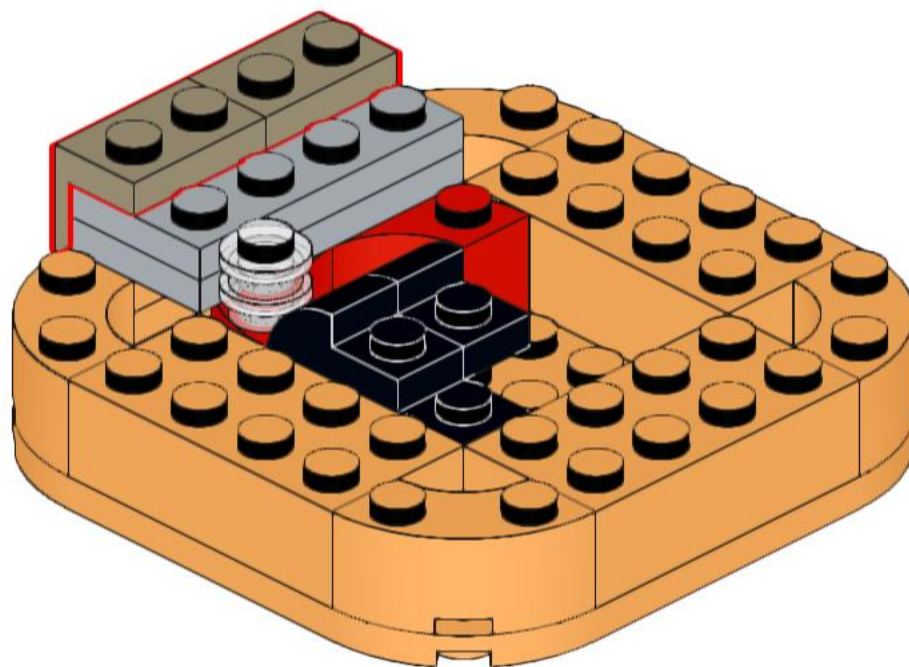
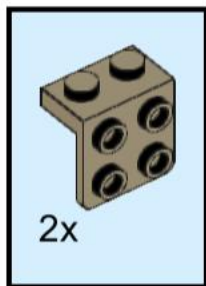

11

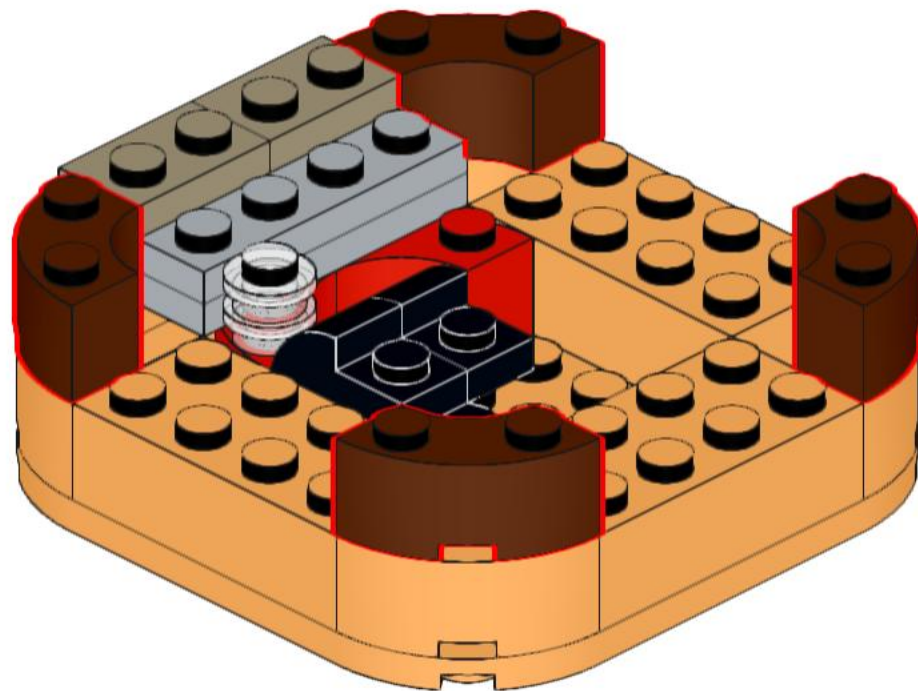
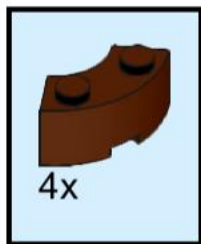

12

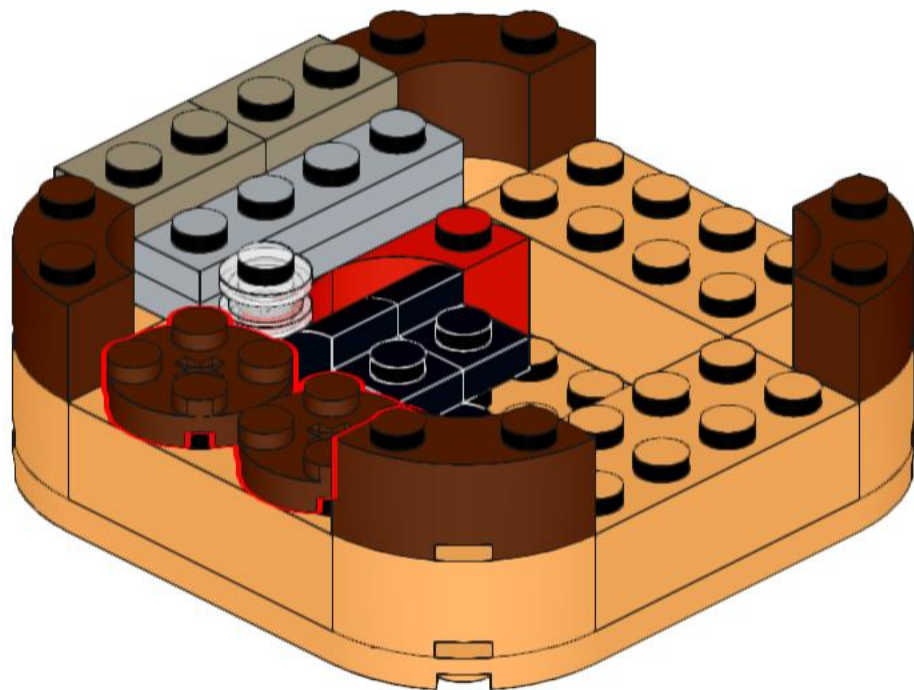
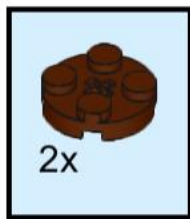

13

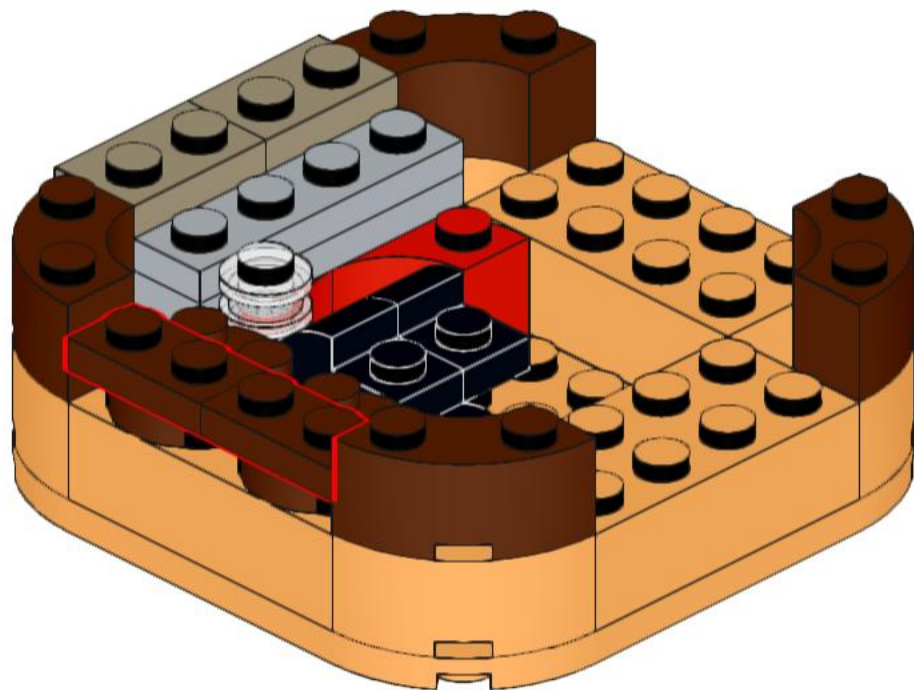
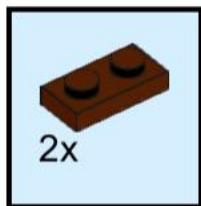

14

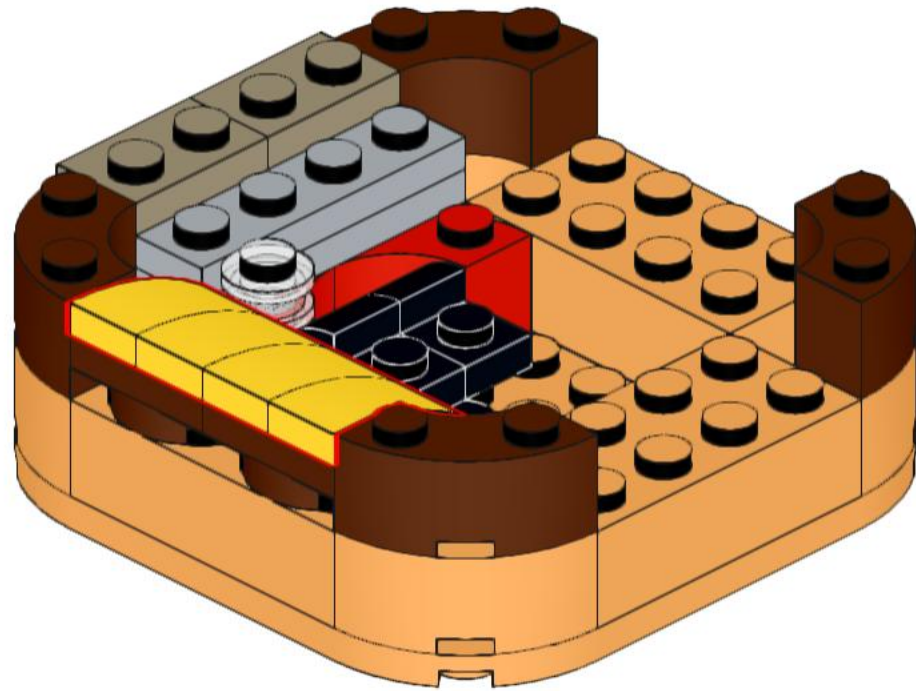
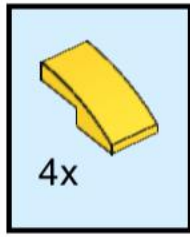

15

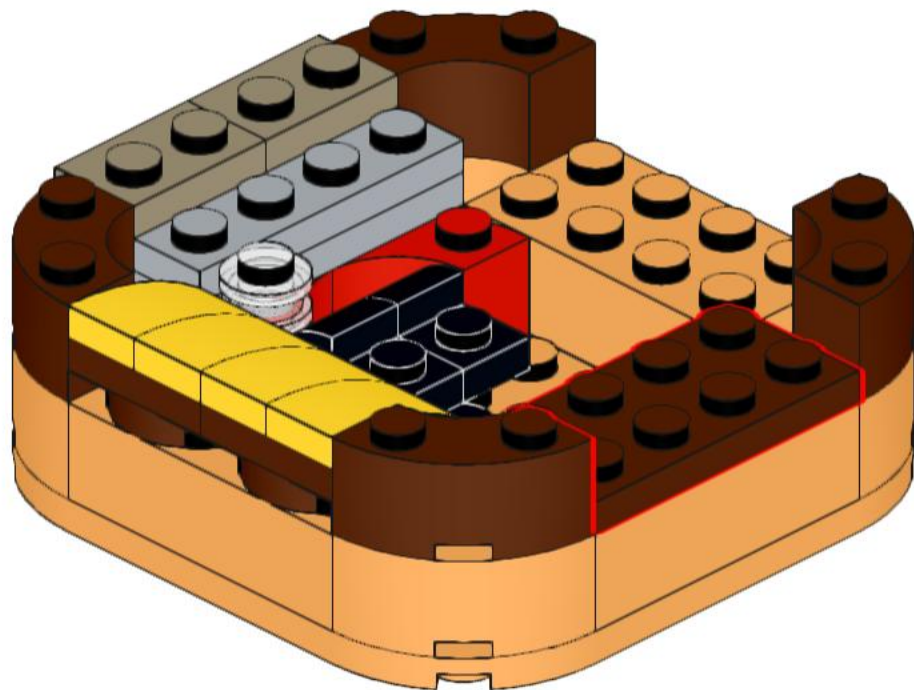
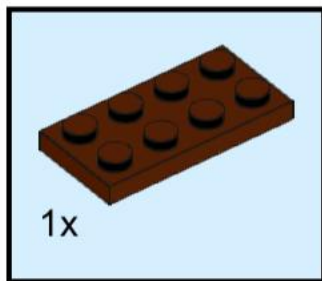

16

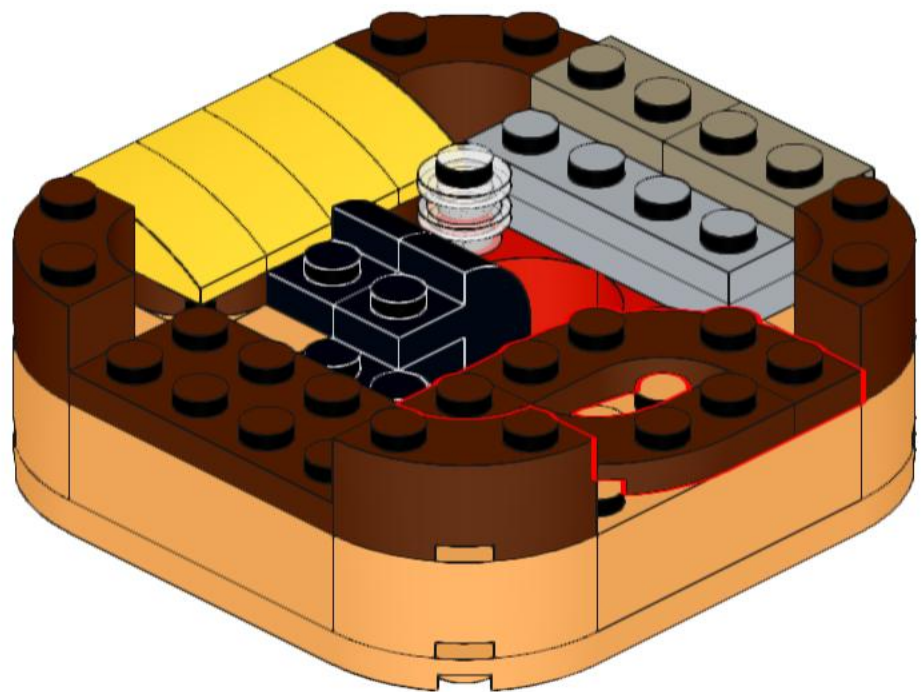
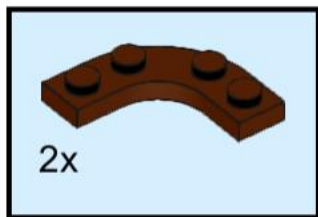

17

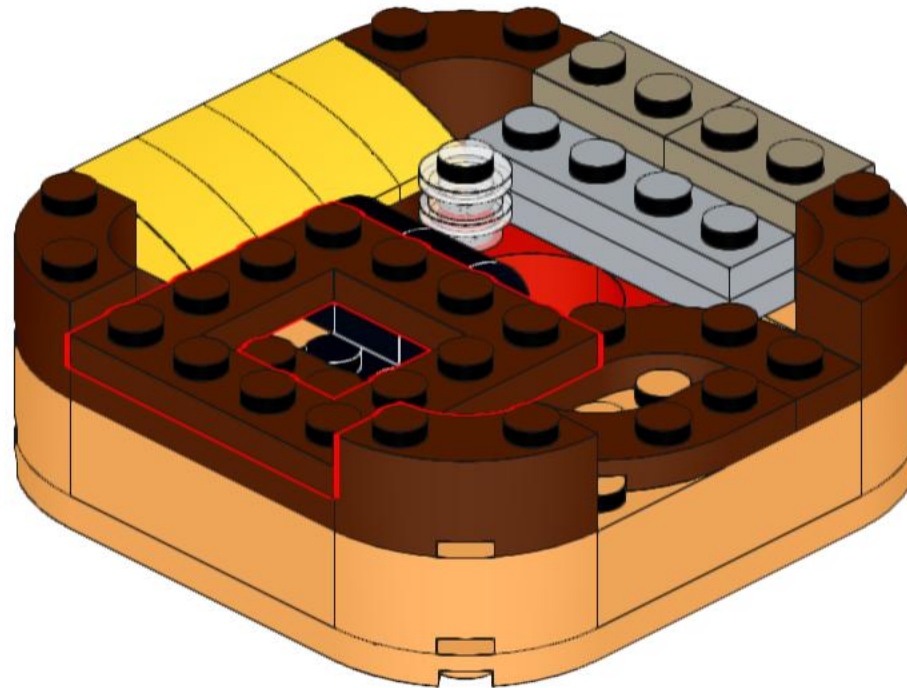
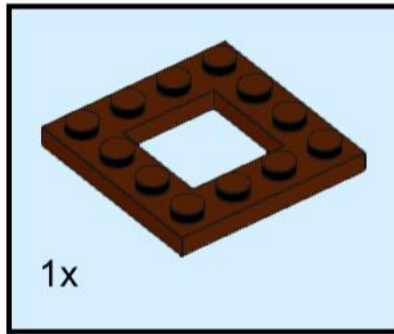

18

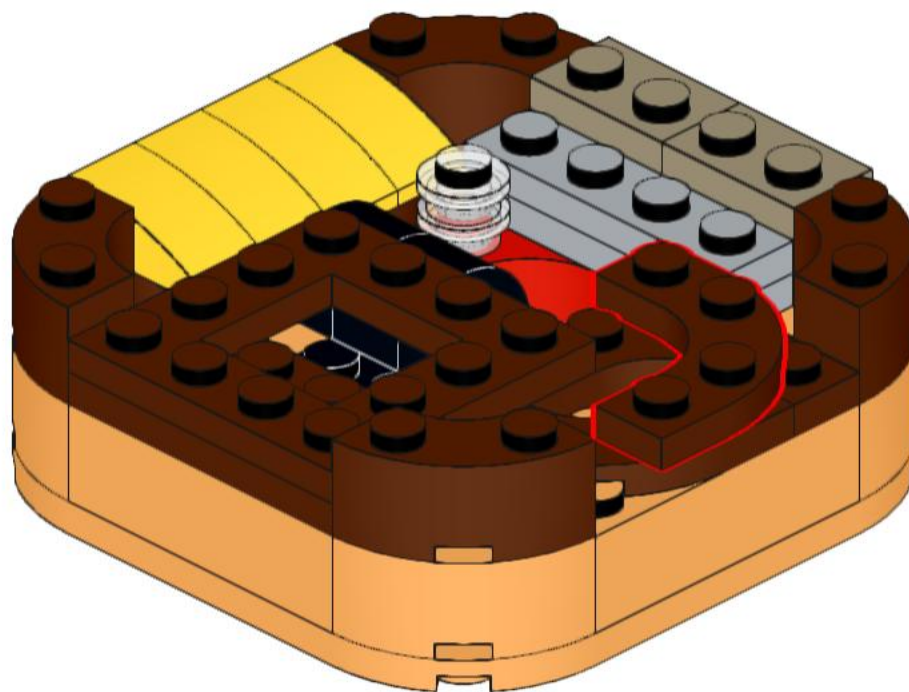
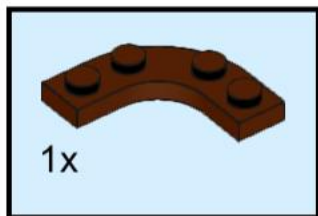

19

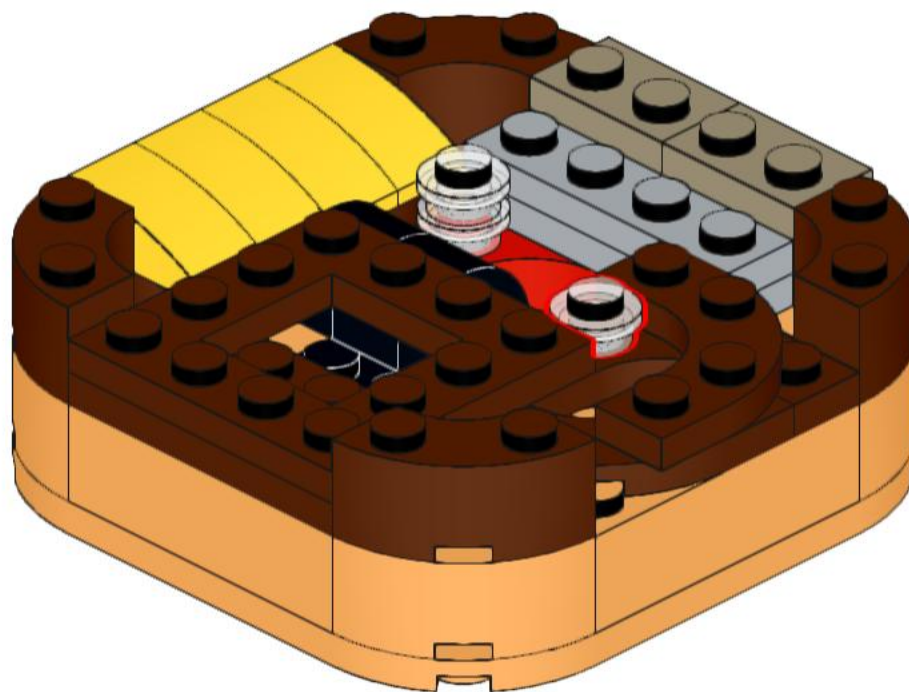
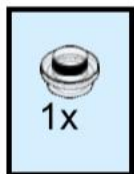

20

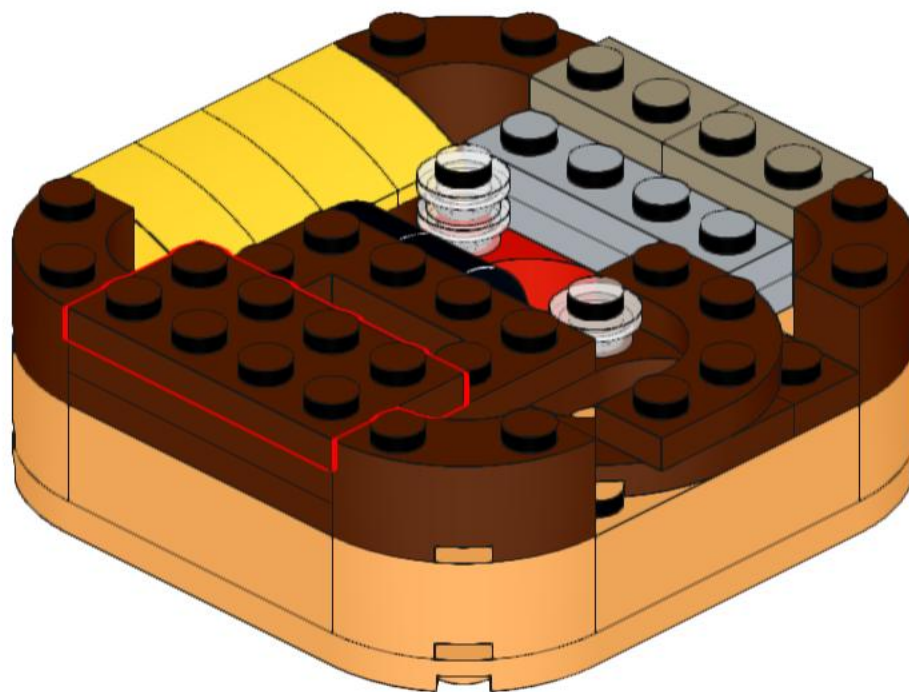
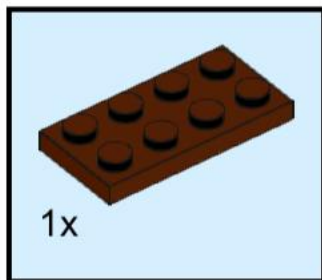

21

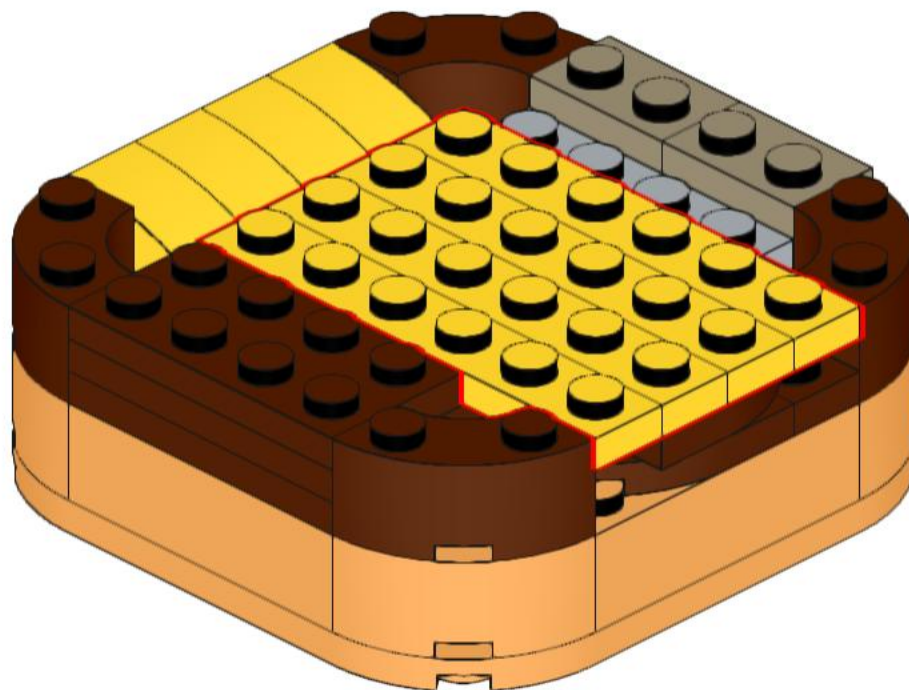
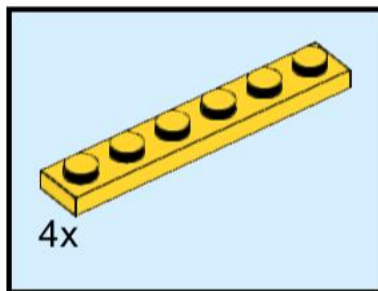

22

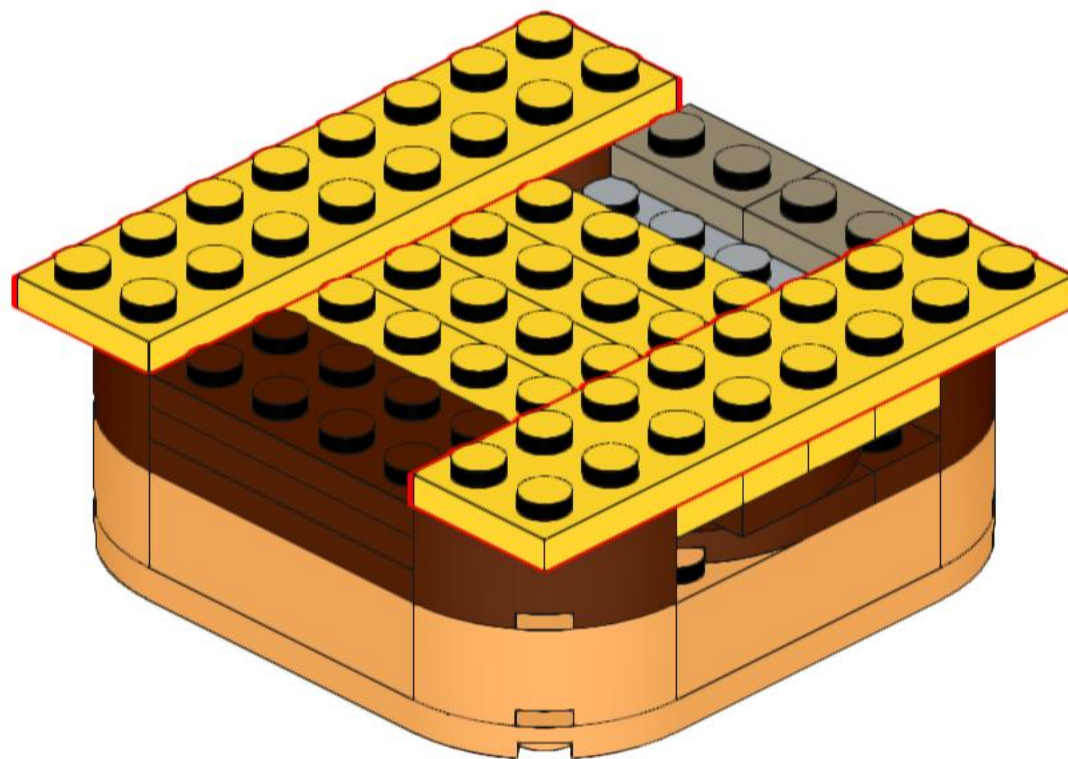
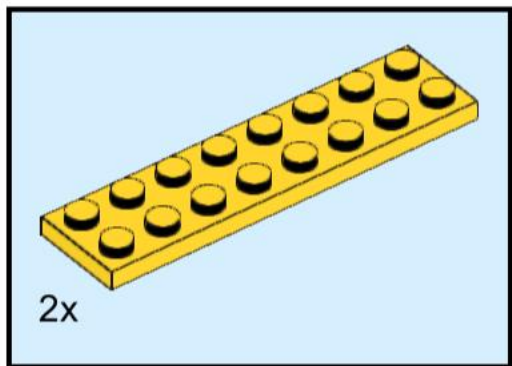

23

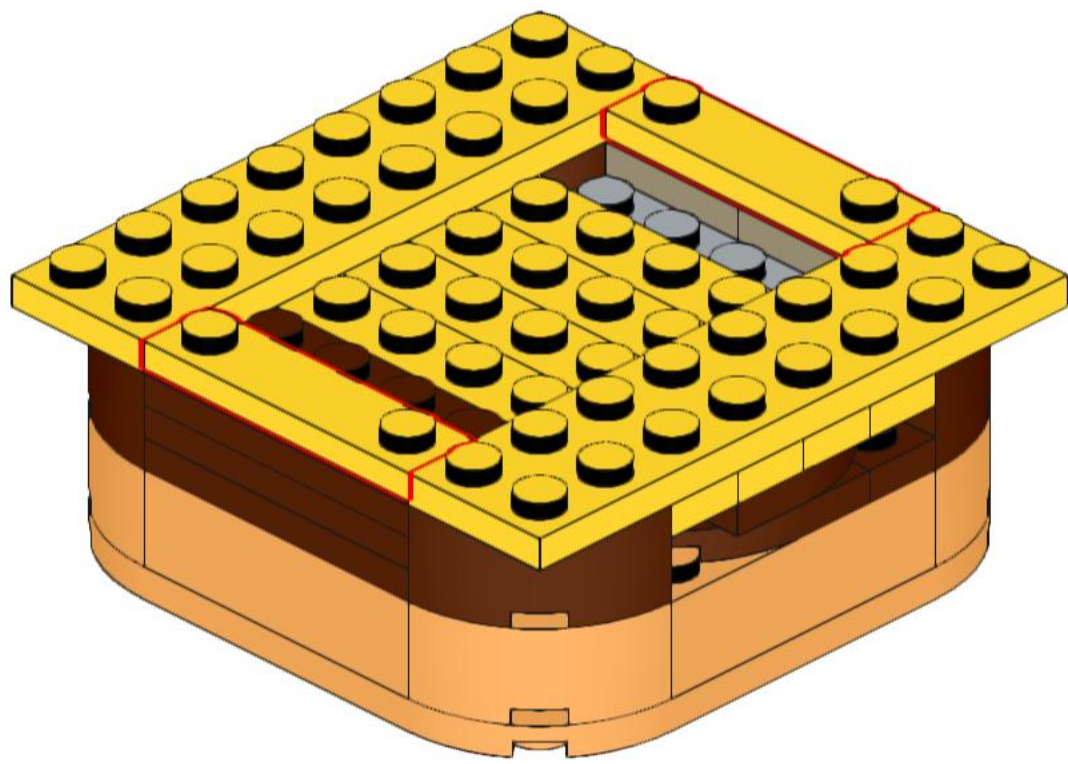
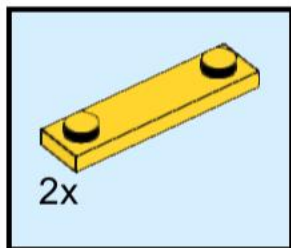

24

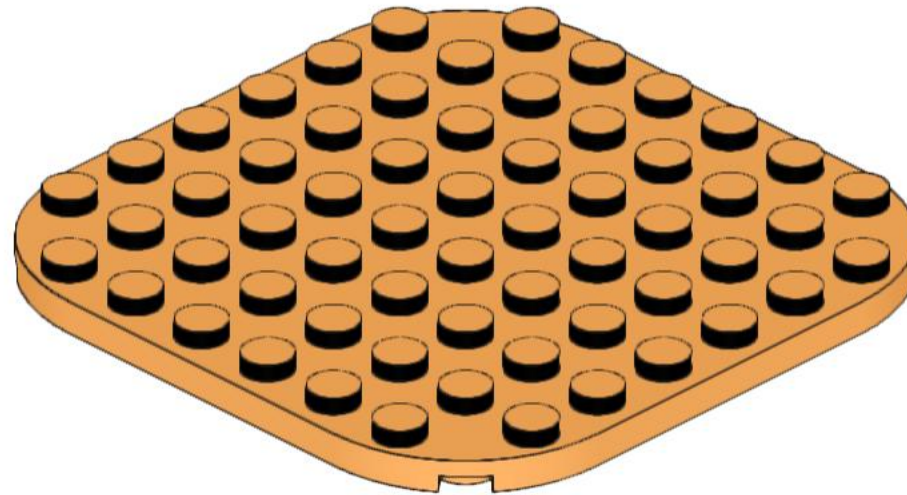
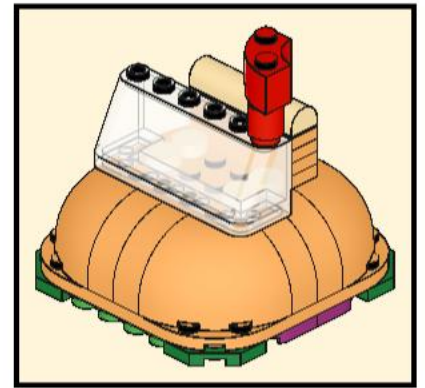
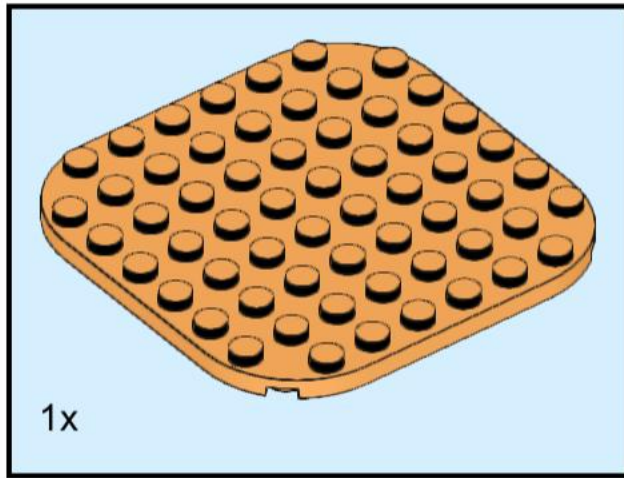

25

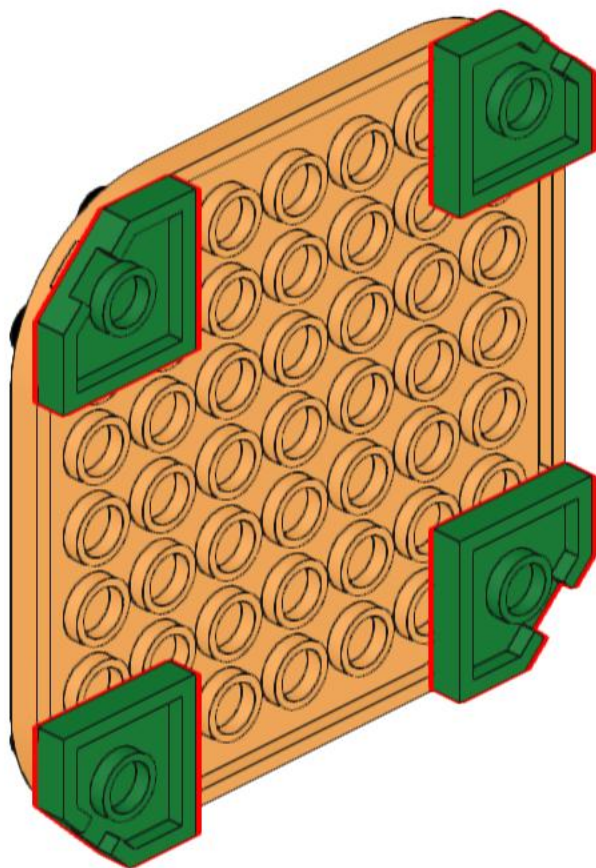
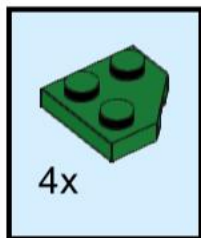

26

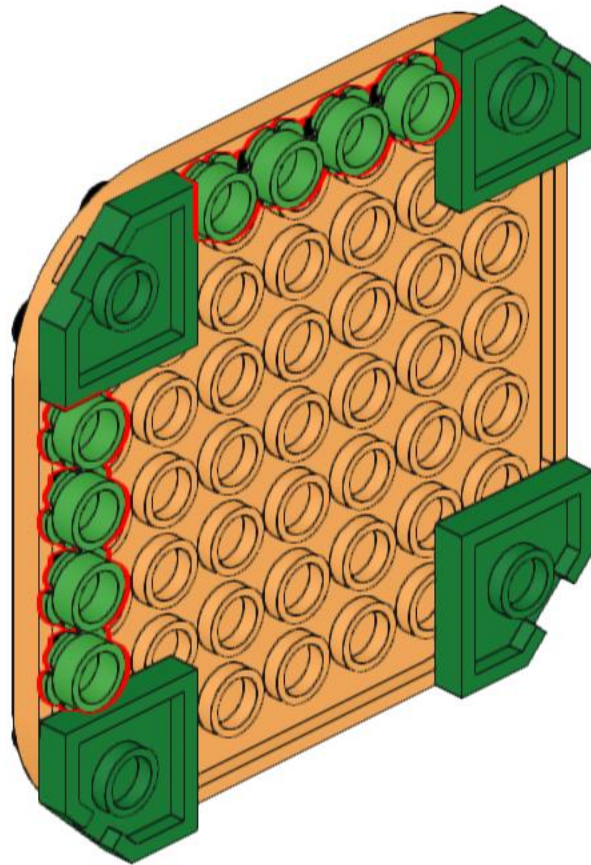
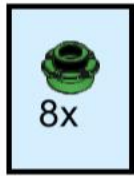

27

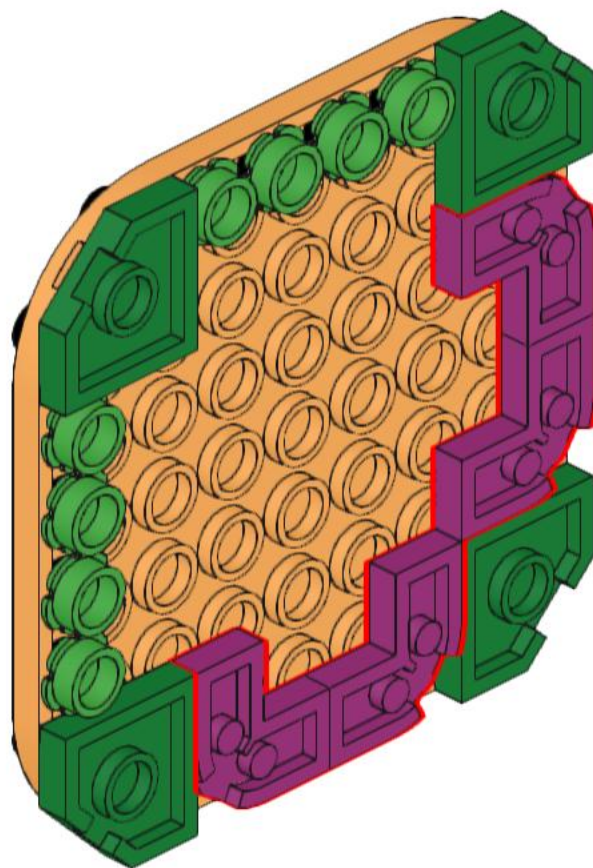
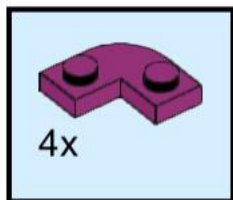

28

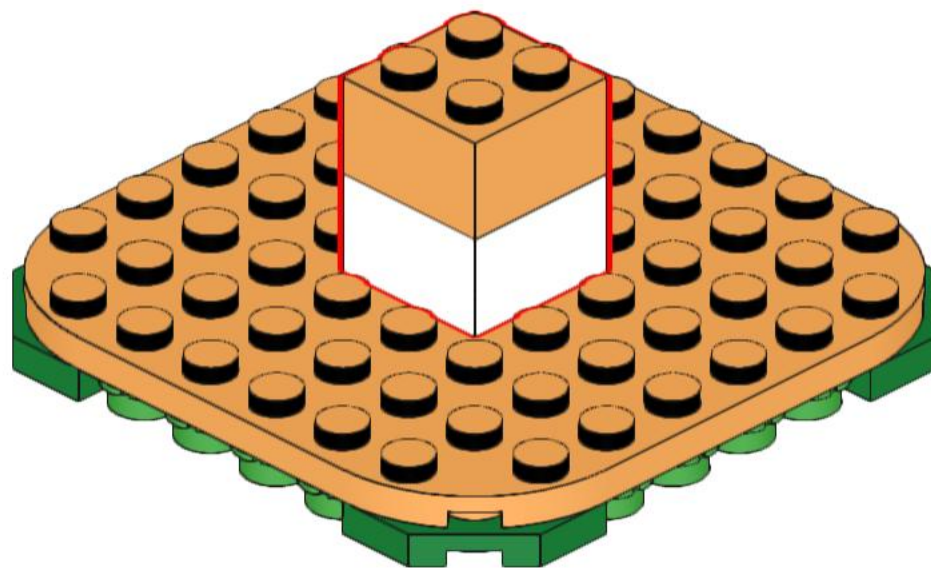
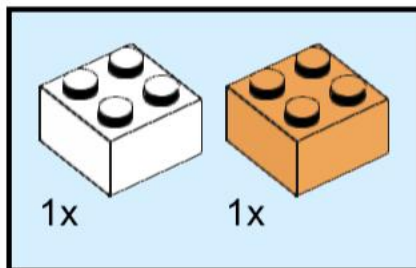

29

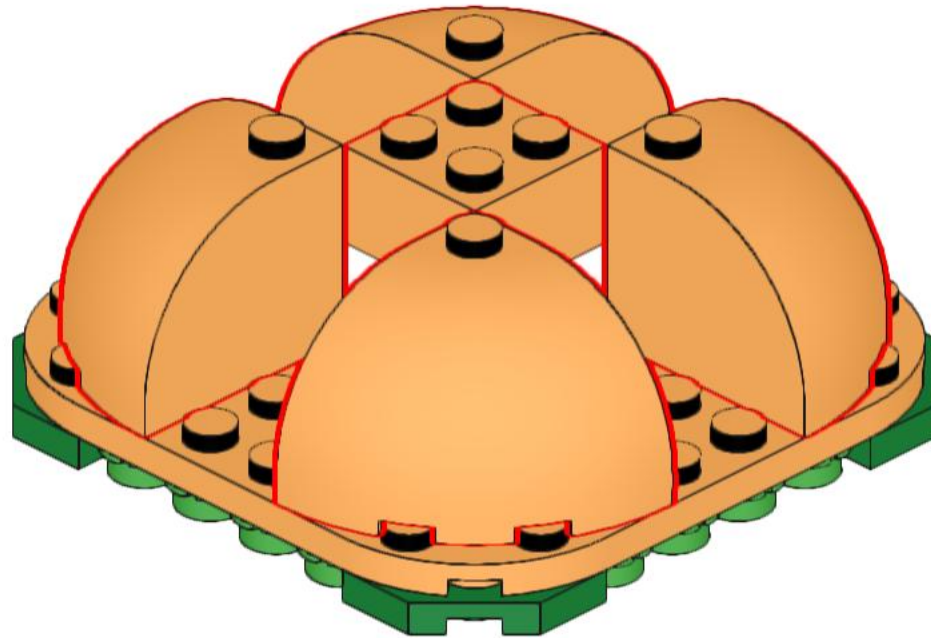
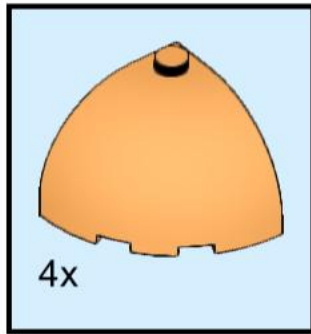

30

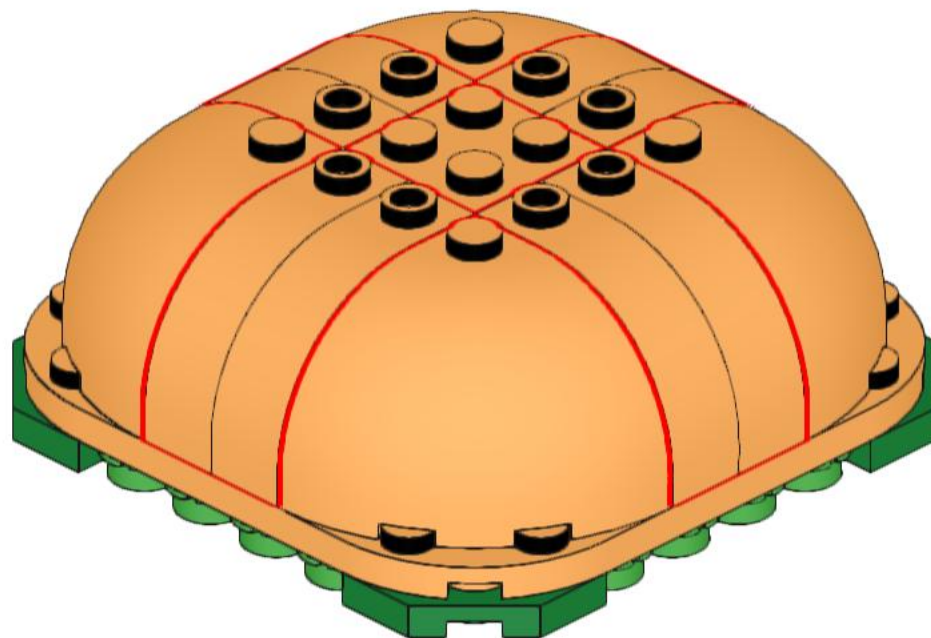
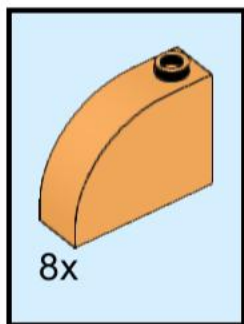

31

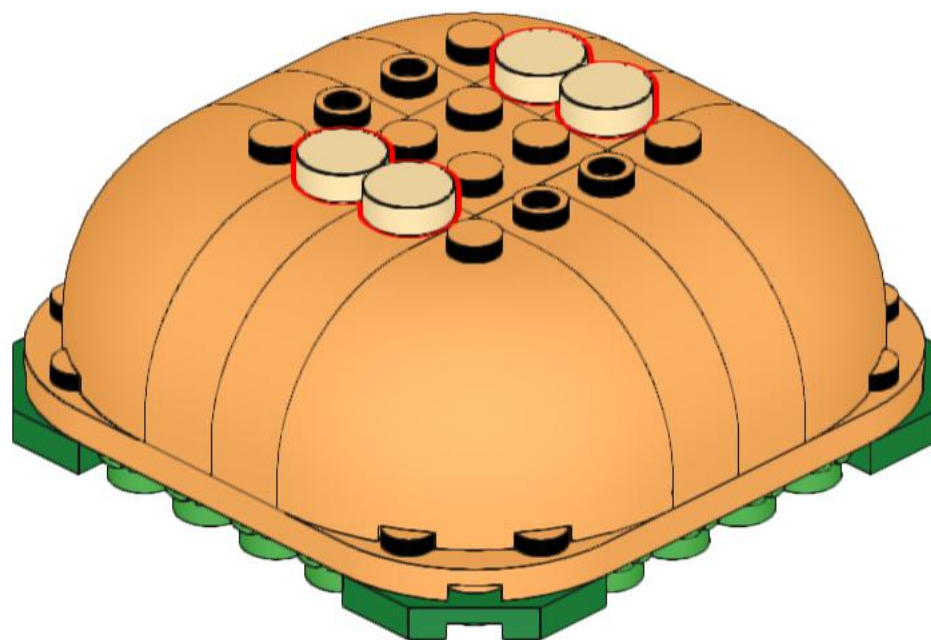
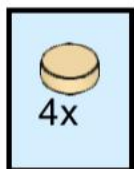

32

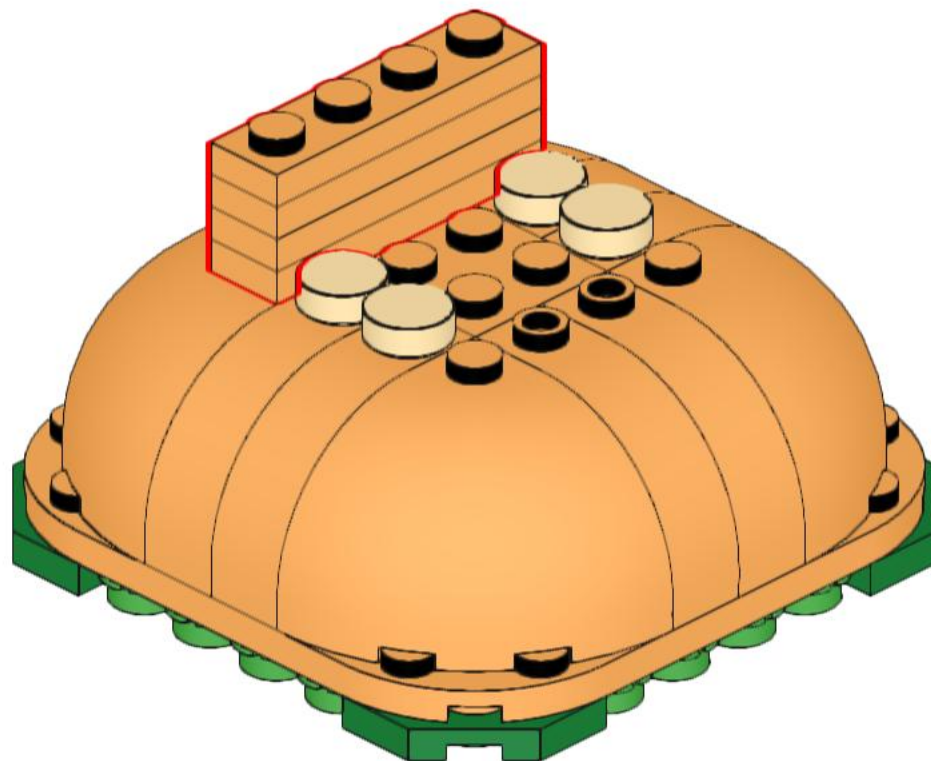
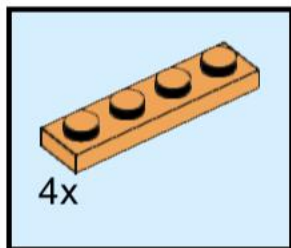

33

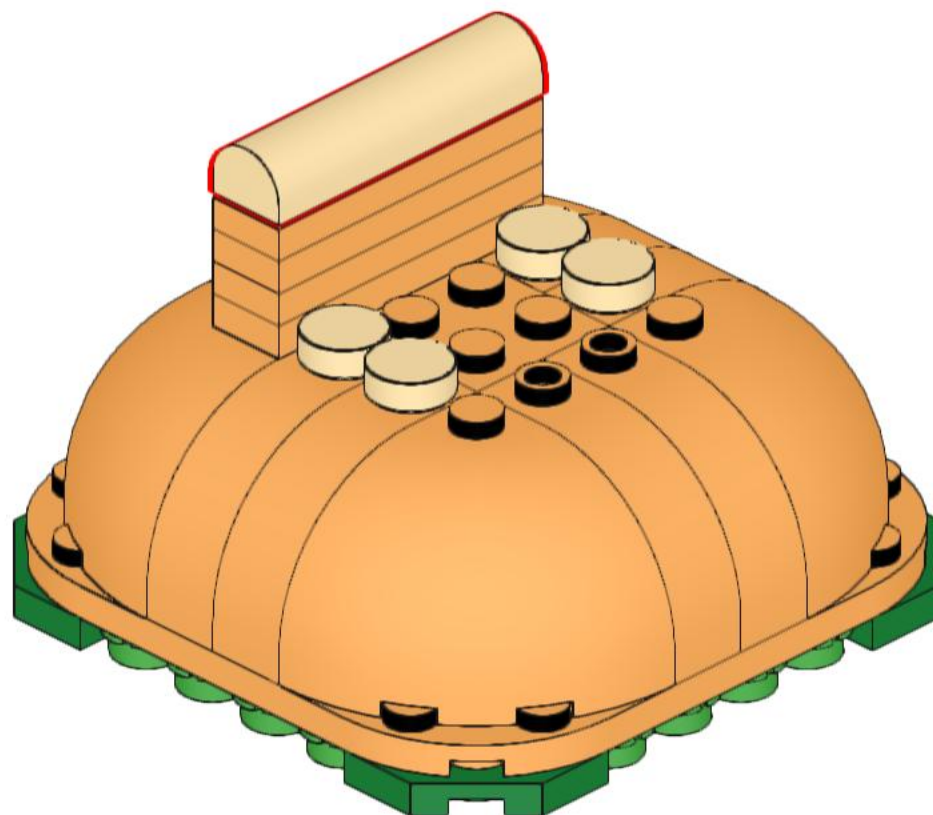
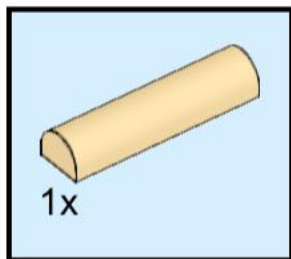

34

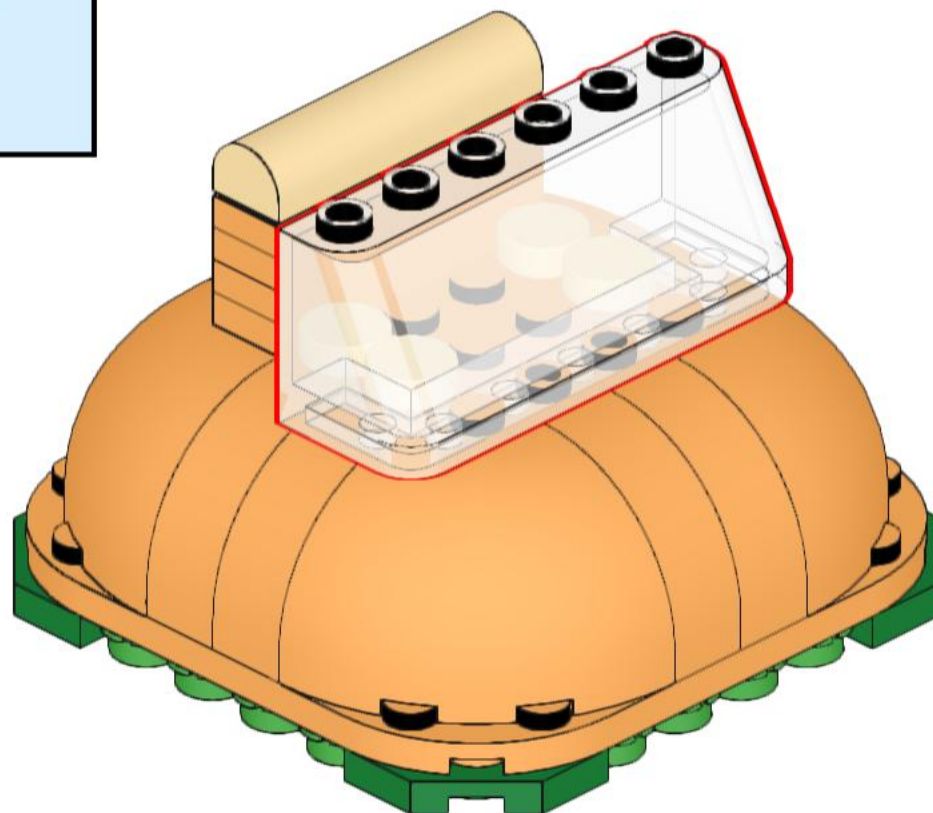
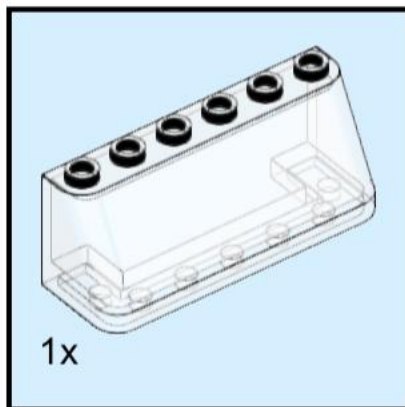

35

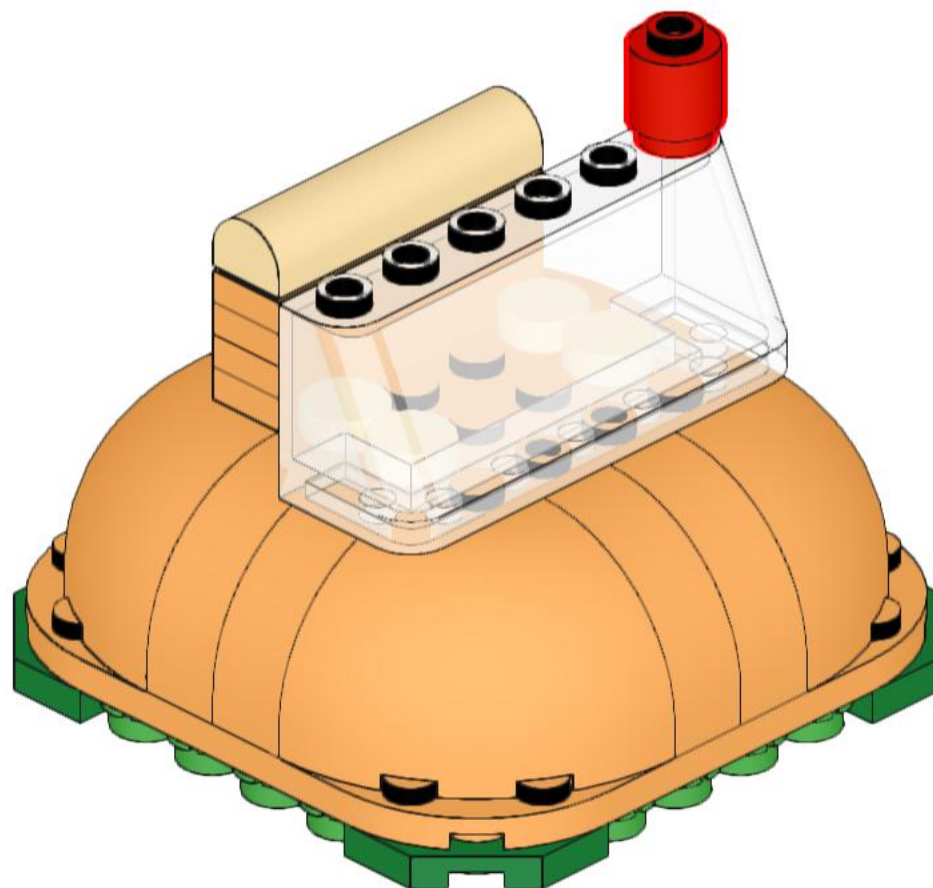
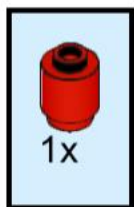

36

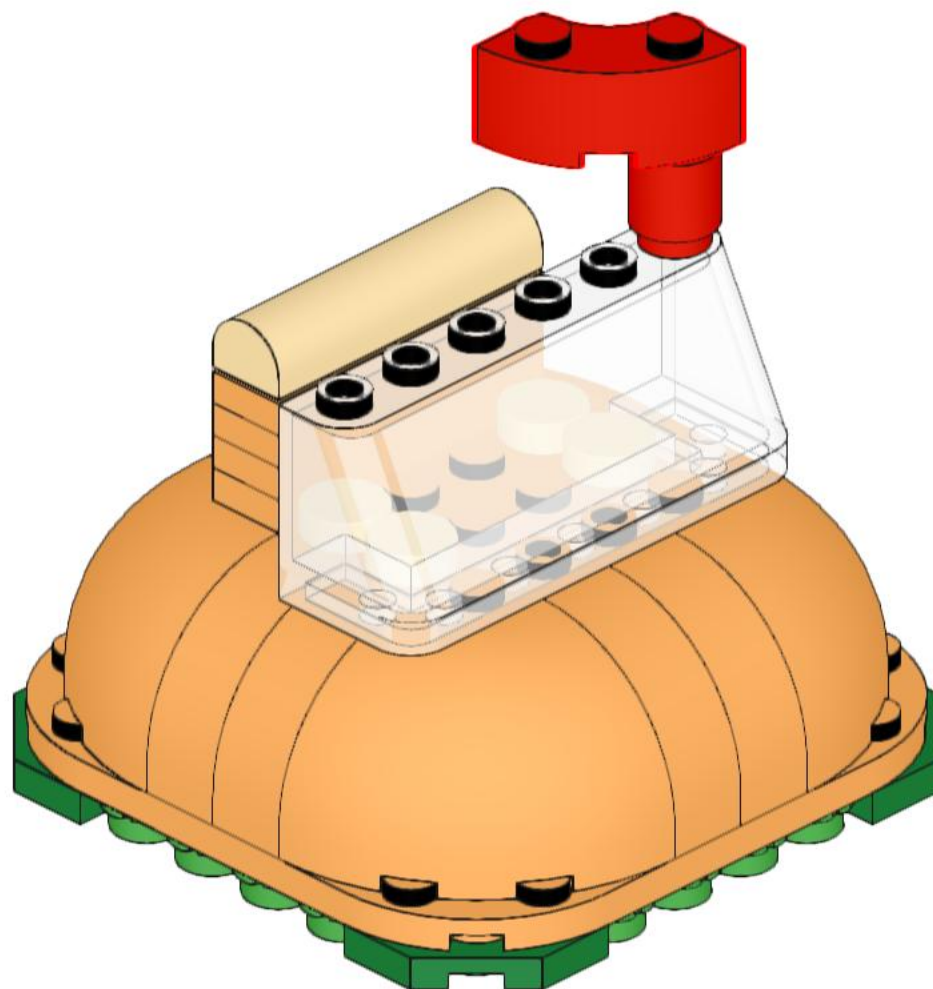
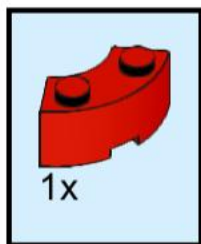

37

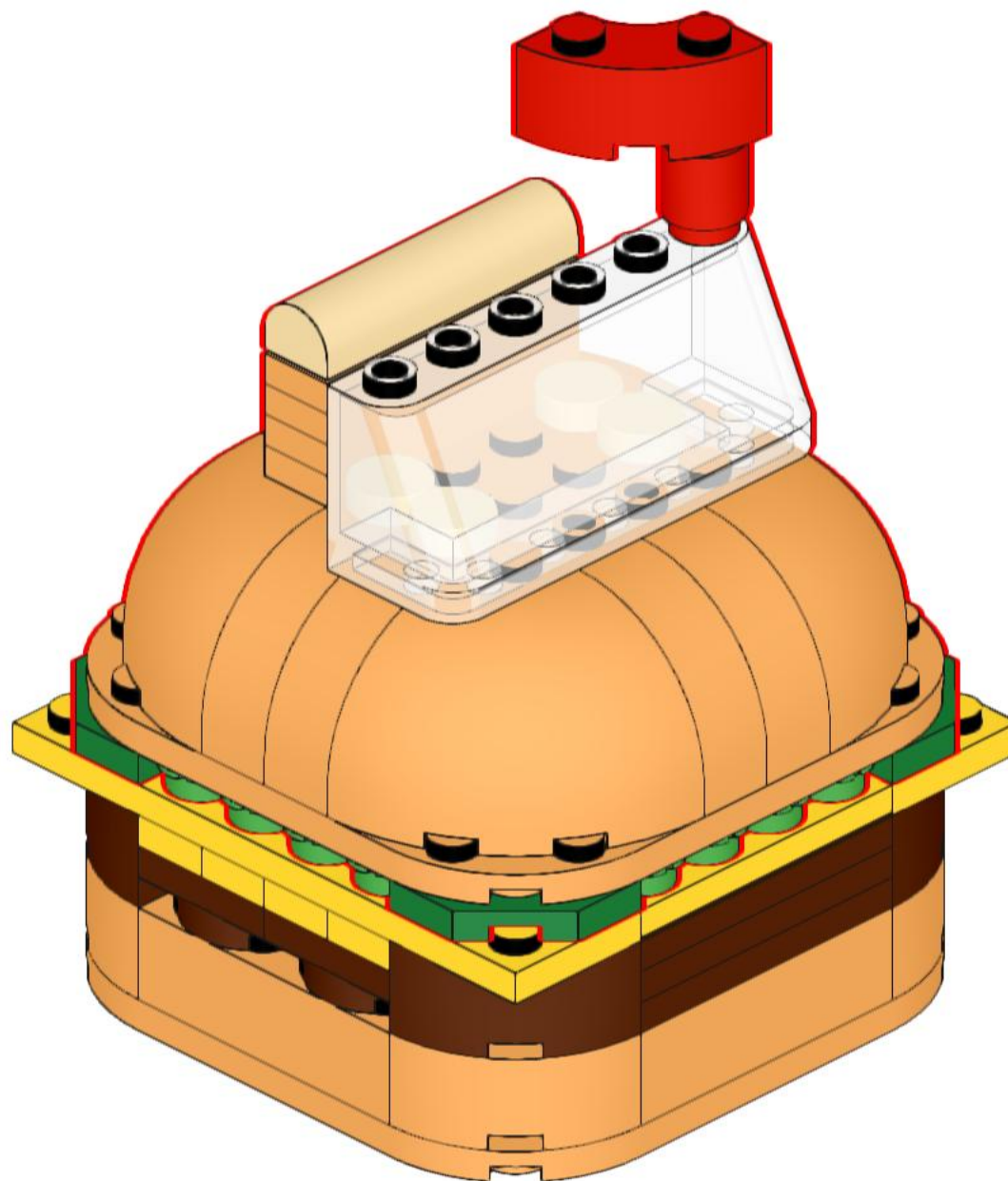

38

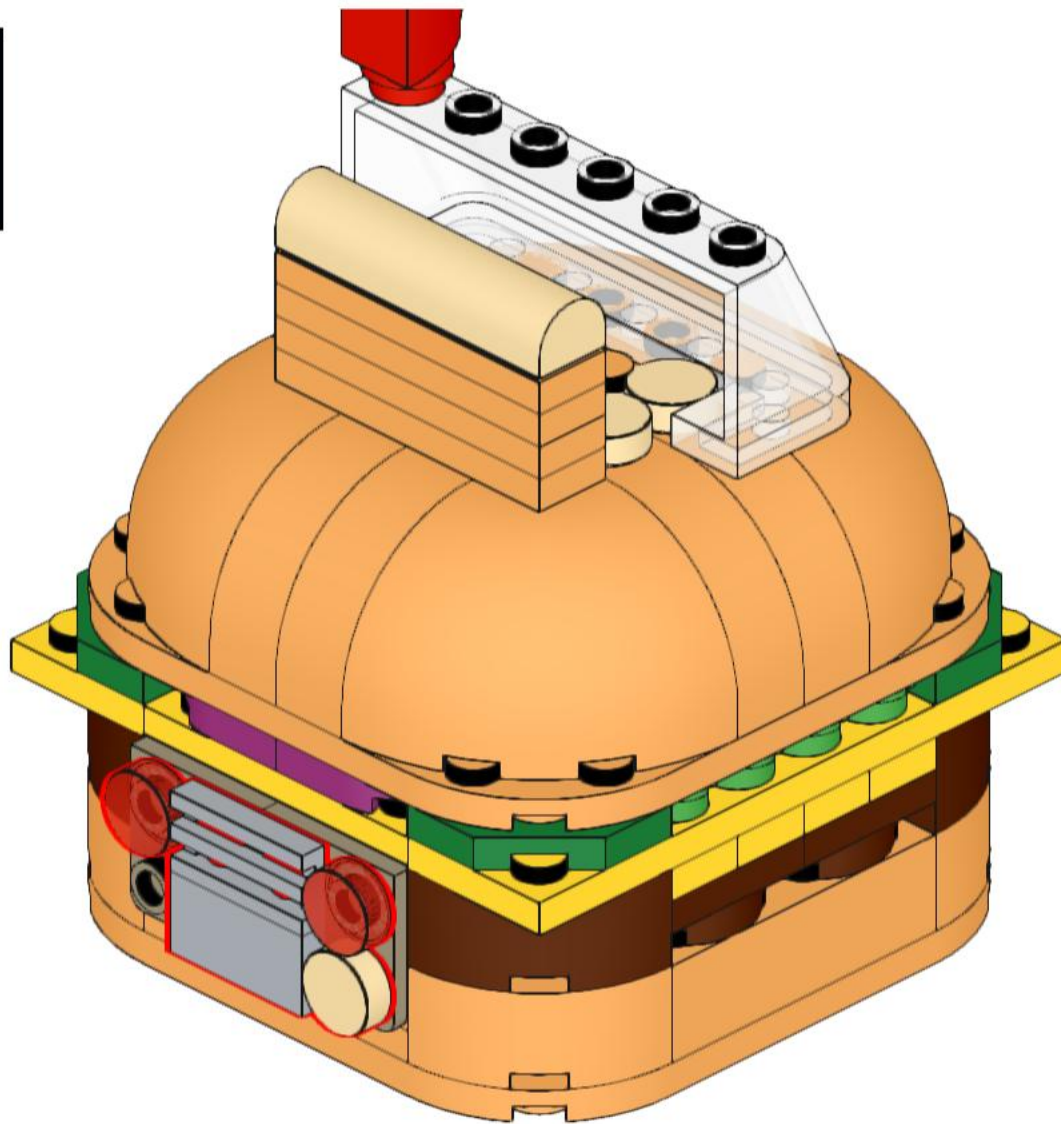
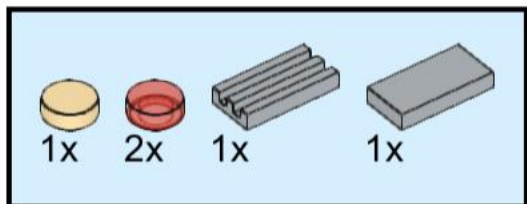

39

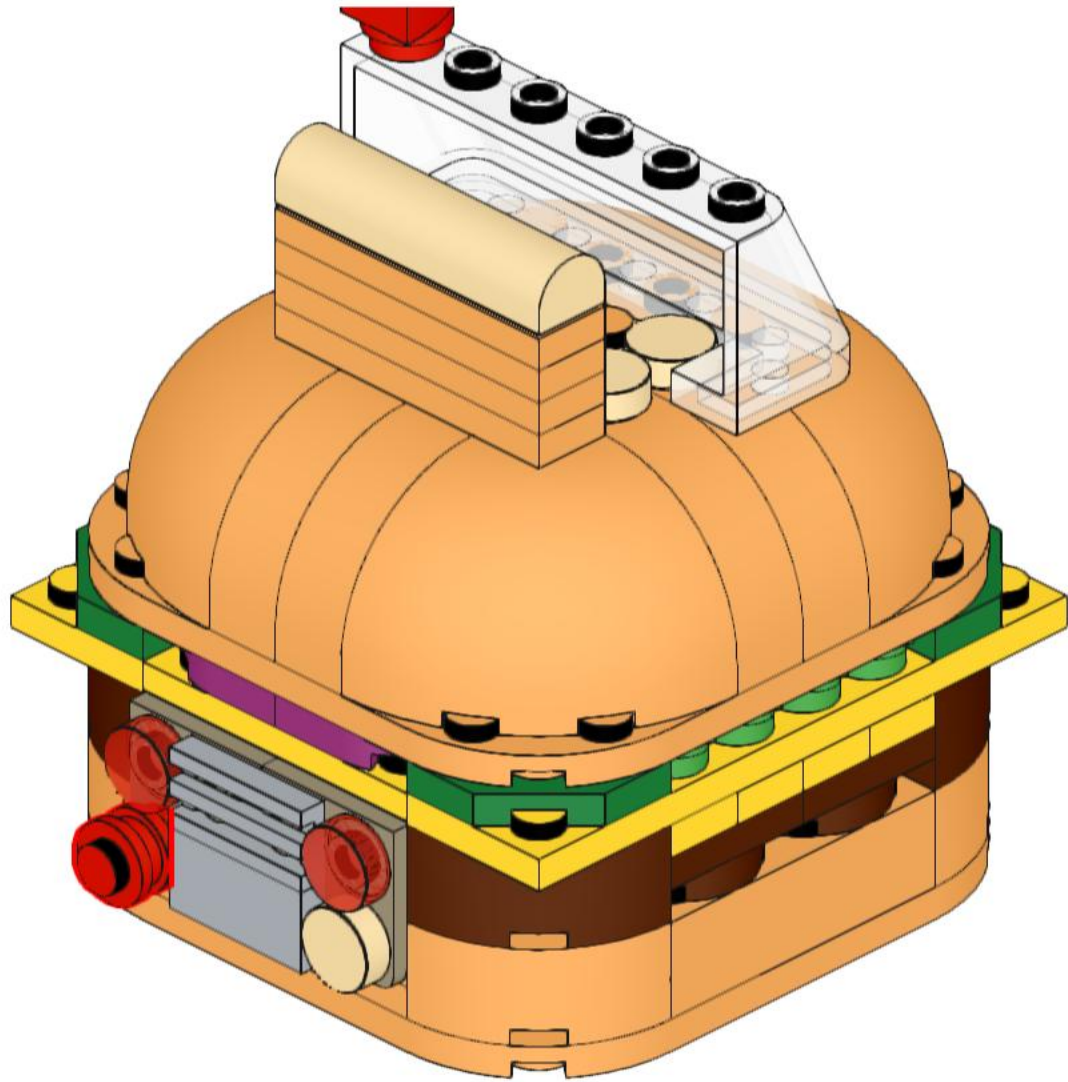

40

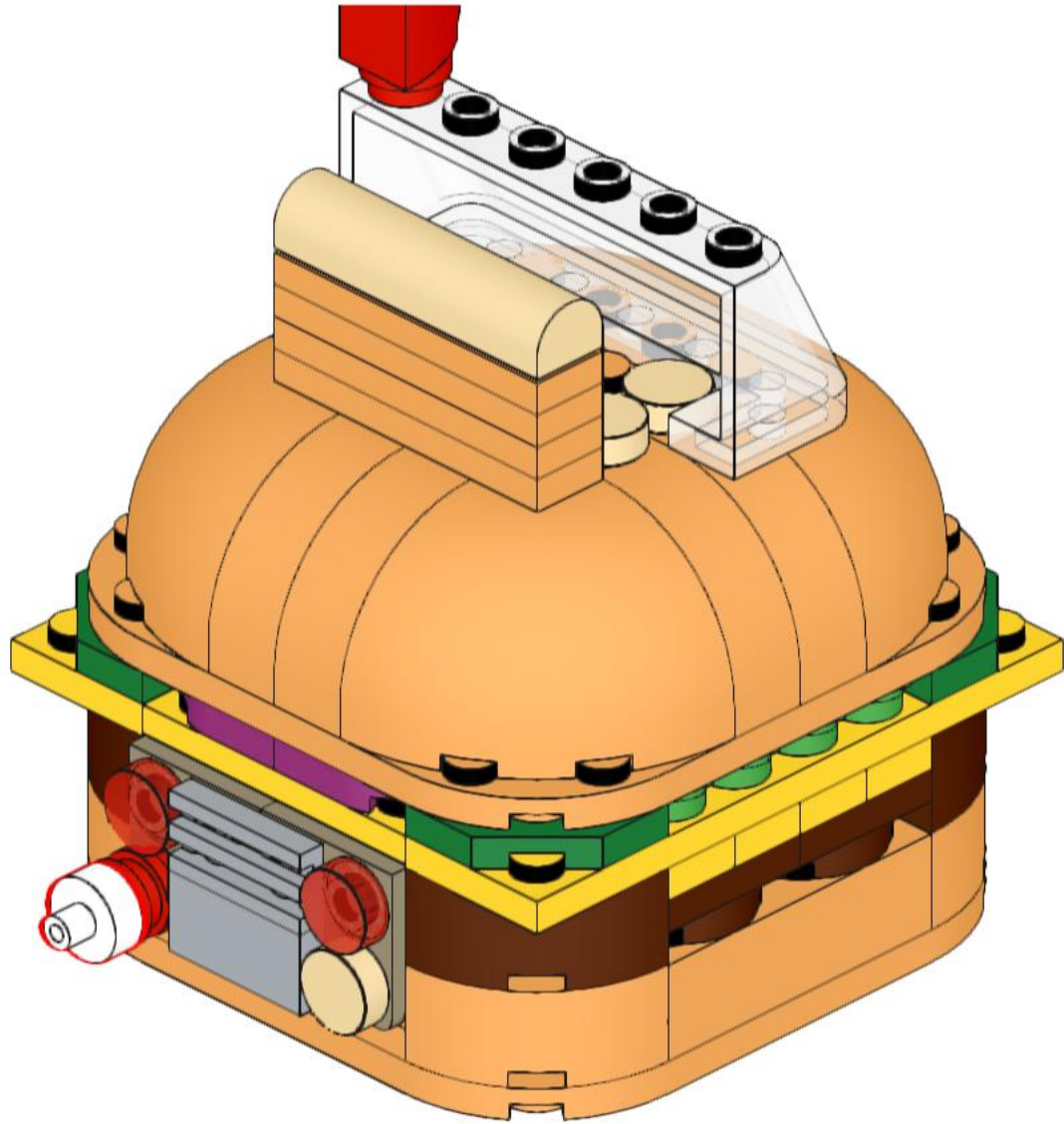
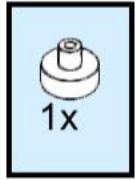

41

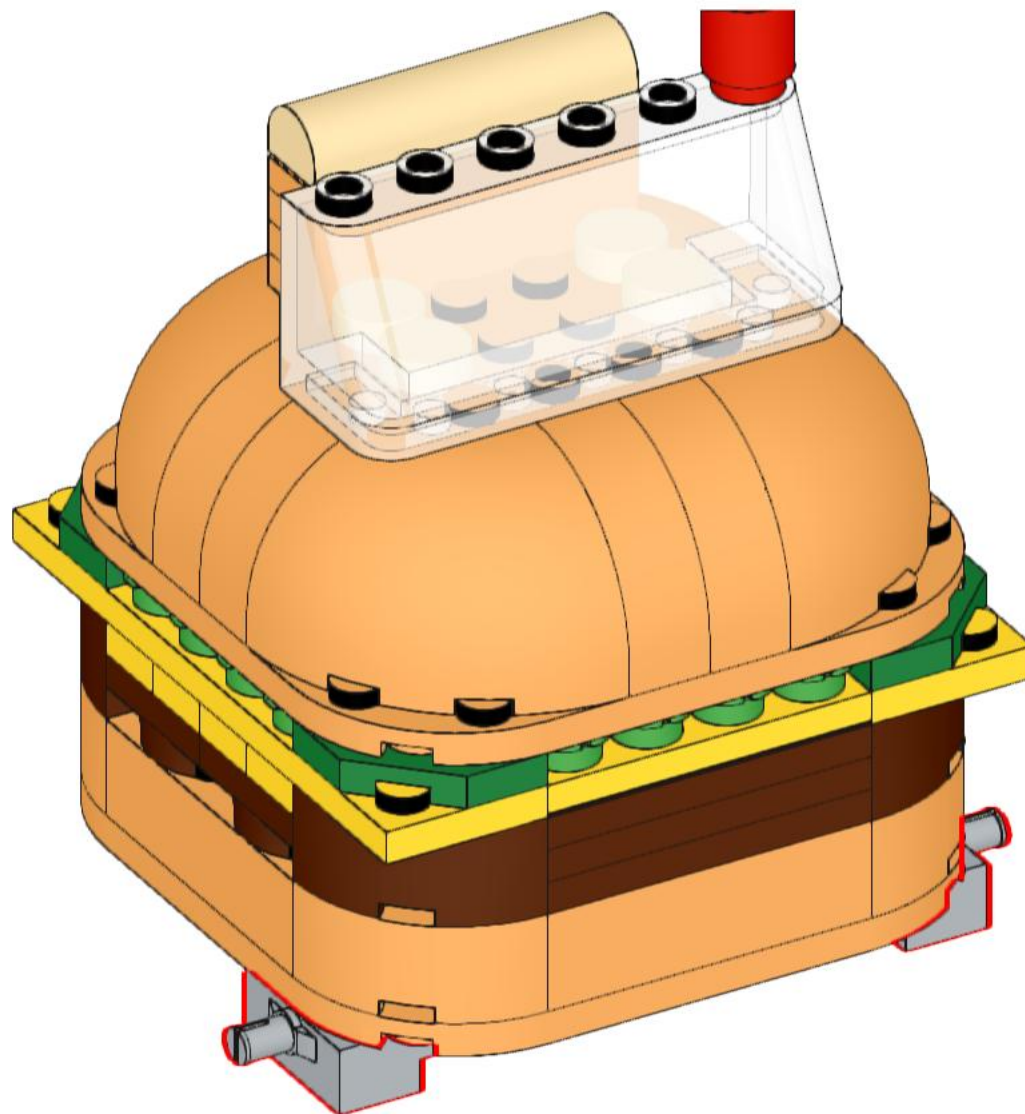
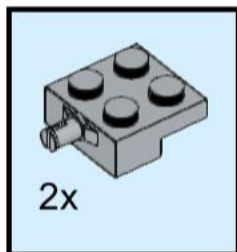

42

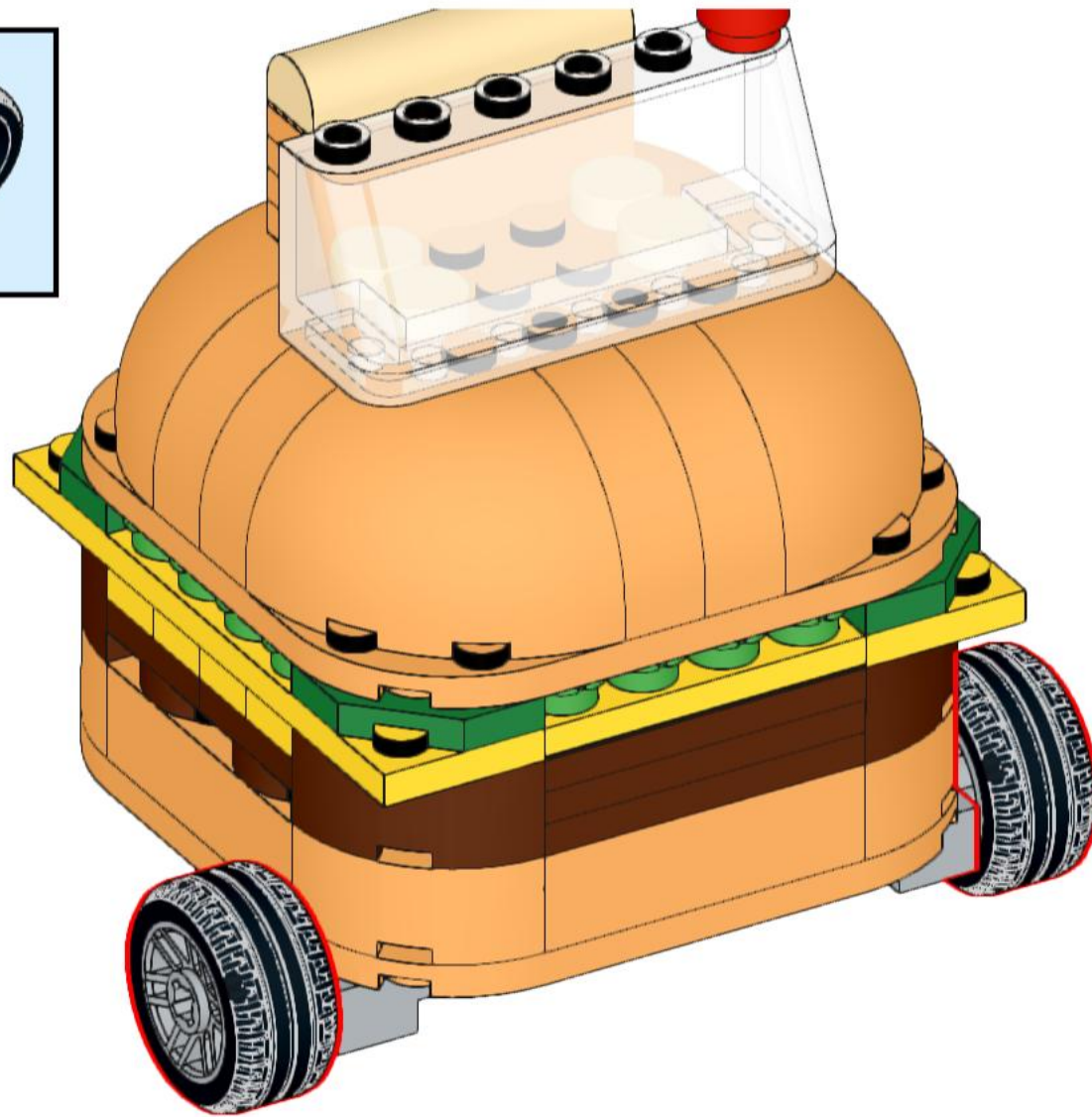
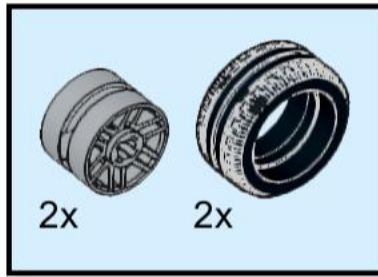

43

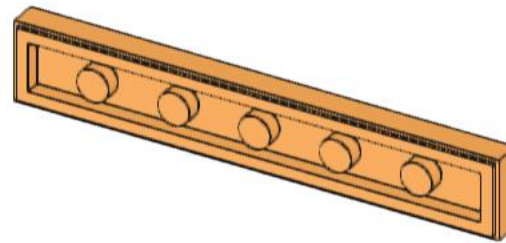
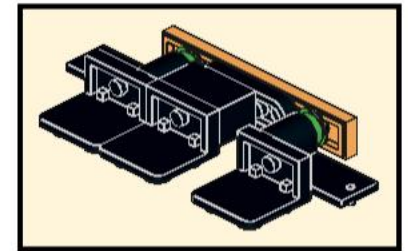
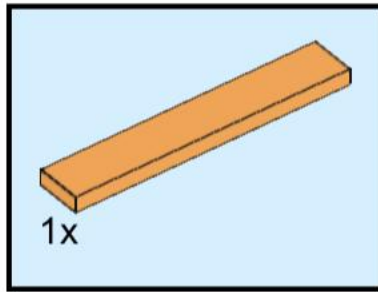

44

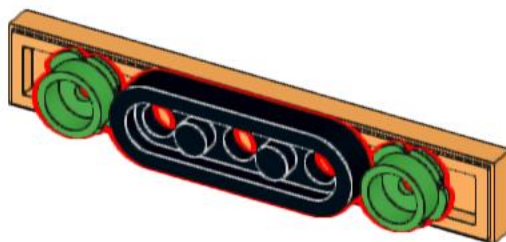
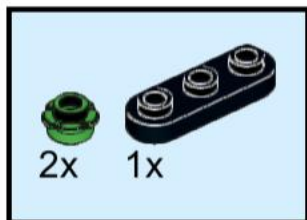

45

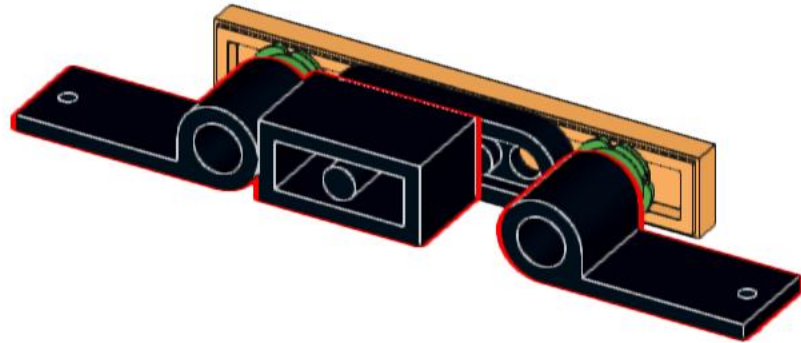
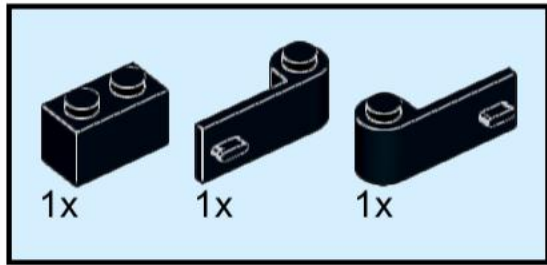

46

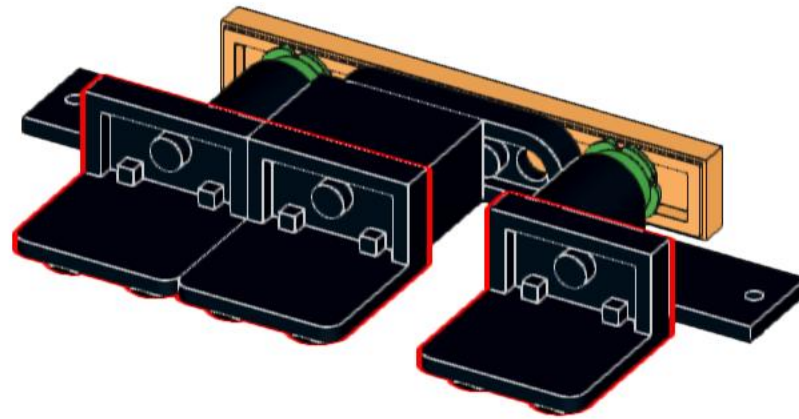
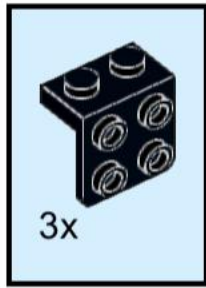

47

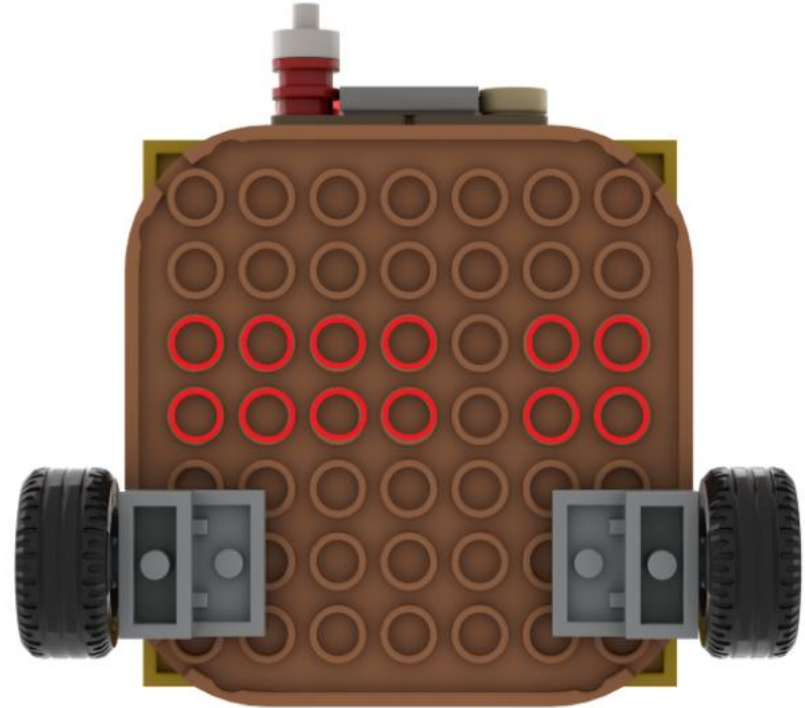
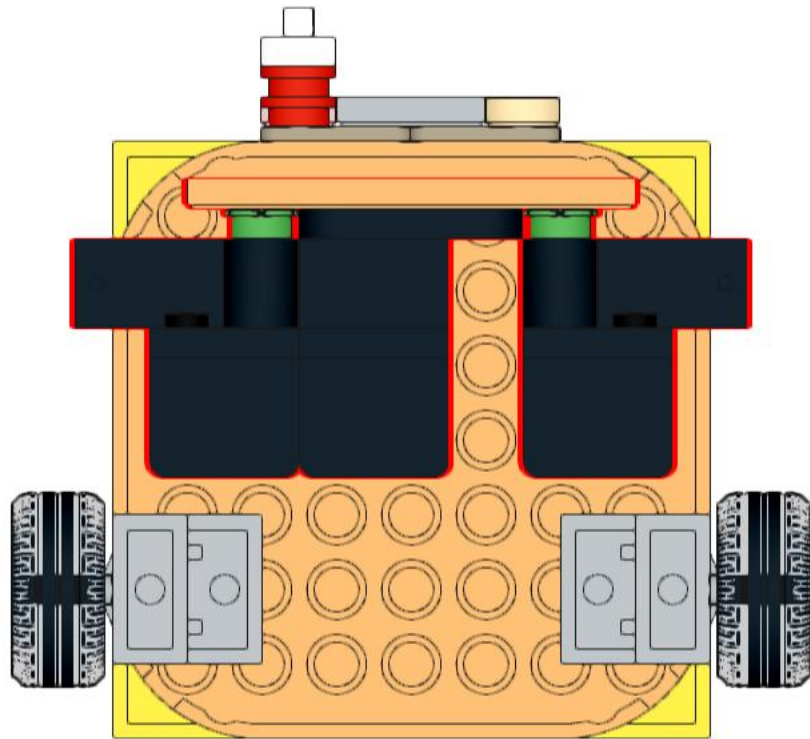

48

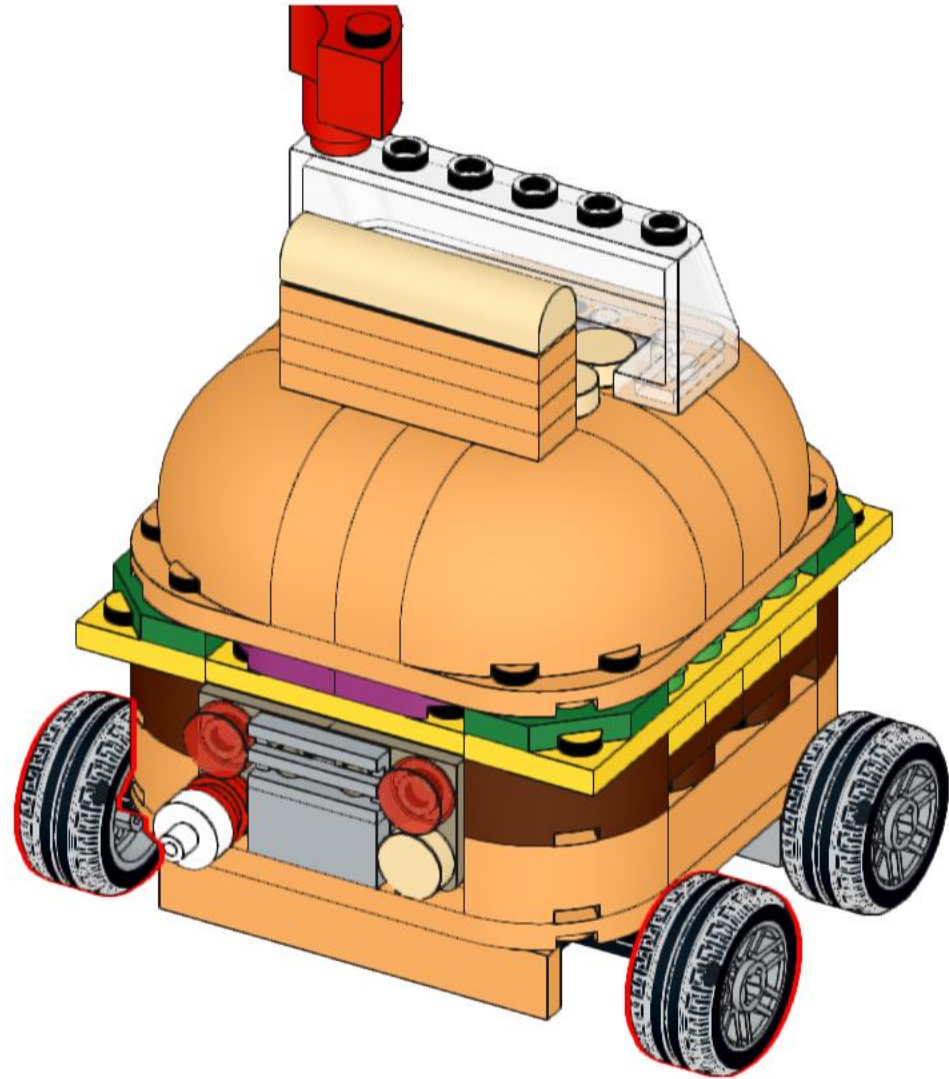
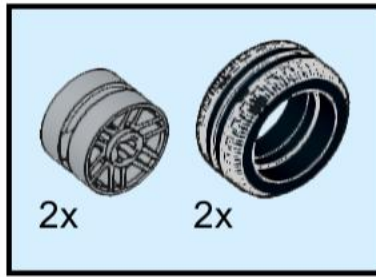

We're using an illegal technique to attach the back wheels. Unfortunately this is the only way to do this given the pieces in the set. Insert the door into the top of the wheel as you can see in the image above. If there's not enough friction try rotate the wheel until you feel it "lock" into place.